

Manufacturers of specialist surgical instruments



Manufacturers of specialist surgical instruments

We are **Surgitrac® Instruments** a multinational manufacturer and distributor of specialist surgical instruments for use in Ophthalmology.

Our manufacturing site is ISO 13485:2016 certified.

Surgitrac Instruments UK is ISO 13485: 2016 and EN ISO 13485:2016 certified.

We offer:

- Quality assured, CE marked products, manufactured to internationally recognised standards.
- Transparency in our supply chain, no forced, or child labour is used during our manufacturing.
- A continuous supply of products, due to our capacity to manufacture millions of instruments each year.

We are specialists in single-use instruments

Ophthalmic instruments arrive sterile, and ready to use in convenient boxes of 10.

We offer any combination of instruments assembled as sterile, sets and procedure packs.

Procedure packs include a selection of instruments and associated items such as drapes, swabs and gallipots.

Instruments sets include two or more items, sterile and in a convenient wrap or tray ready to use.

Packs that we offer include:

Cataract | DMEK basic | DMEK complete | Eye bank | Cross Linking | Lasek | Lasik | Intravitreal injection (IVT)
Vitreoretinal (VR) | Lacrimal wash-out | Chalazion | Sub -tenon anaesthesia.

Sets that we offer include:

Cataract | Glaucoma | Pterygium | Biopsy & minor procedure | Eye lid surgery | Plastic surgery
Sub tenon anaesthesia | Strabismus | Retina of Prematurity (ROP) | Eye bank

Reusable instruments

All of our stainless-steel instruments can be manufactured as reusable versions, in single units.

Non sterile bulk wholesale

Our instruments are available for bulk wholesale. Instruments are supplied packed and ready for sterilisation.

We can offer private label manufacturing through our OEM business. Precision instruments featuring your brand can be supplied as single-use sterile or as non-sterile units.

Contact us info@surgitrac.com more information.

Using this catalogue

This catalogue is designed to provide specific information about our products and their technical specifications.

Product details

Product code number – Single use S codes, Reusable R codes and Titanium T codes.

Colour indicates material used to manufacture product:



Single-Use

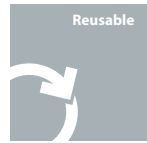

Reusable



Titanium

- Single Use Instrument Code.
- Stainless Steel Reusable Instrument Code.
- Titanium Reusable Instrument Code.

Capsulorhexis forceps cross action - SC33 - RUC33 - TIC33

Length: 11.5 cm
Handle length: 82 mm
50° angles platform notched tips



Description details product specifications such as handle length.

Product images are not shown at actual size.

The technical illustration specifies details such as tip measurements.

Detailed technical files for instruments are available at request.

SHORTCUTS:

- About
- User guide
- Shortcuts
- Forceps
 - > Capsulorhexis
 - > Fixation
 - > General
 - > Lens
 - > Tying
- Manipulators and Choppers
- Speculums
 - > Wire
 - > Mechanical
 - > Paediatric
- Scissors
- General ophthalmic
- Corneal and Refractive
- Measurers and Markers
- Curettes and clamps
- Needle holders
- Lacrimal

CONTENTS:

Page 2: About

Page 4: User guide

Page 5: Shortcuts

Page 7: Forceps

Page 19: Manipulators and Choppers

Page 25: Speculums

Page 31: Scissors

Page 38: General ophthalmic

Page 42: Corneal and Refractive

Page 47: Measurers and Markers

Page 50: Curettes and Clamps

Page 52: Needle holders

Page 55: Lacrimal

Forceps

Capsulorhexis | Fixation | General | Lens | Tying

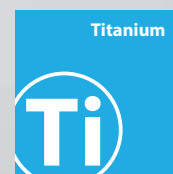
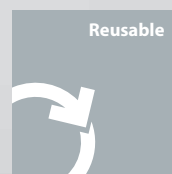
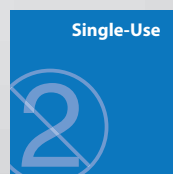
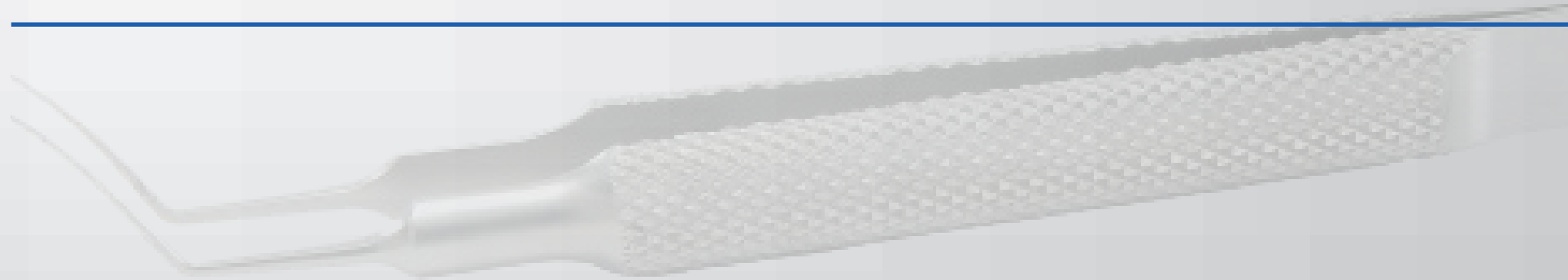

Single Use Instrument Code

Stainless Steel Reusable Instrument Code

Titanium Reusable Instrument Code

Capsulorhexis forceps cross action ▪ SC33 ▪ RUC33 ▪ TIC33

Length: 11.5 cm
 Handle length: 82 mm
 50° angled platform notched tips 0.3 mm



CAPSULORHEXIS

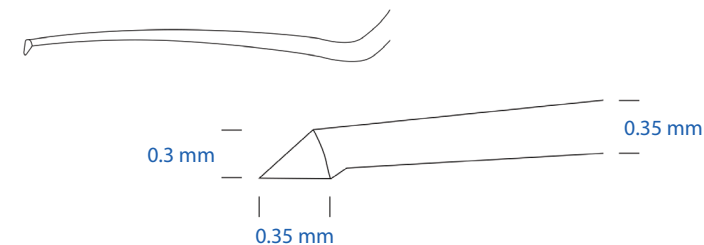

Capsulorhexis forceps curved ▪ SC32 ▪ RUC32 ▪ TIC32

Length: 10.5 mm
 Handle length: 75 mm
 45° angled platform with notched tips 0.3 mm



CAPSULORHEXIS

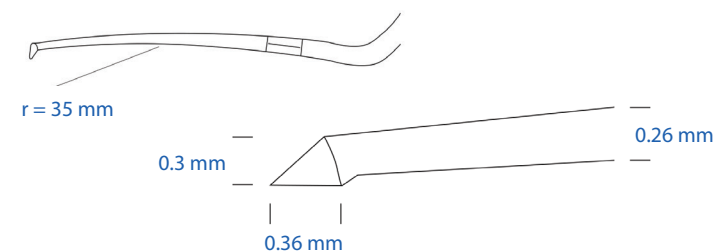

Capsulorhexis round bodied curved ▪ SC34 ▪ RUC34 ▪ TIC34

Length: 10.5 cm
 Handle length: 77 mm
 45° angled platform with notched tips 0.3 mm



CAPSULORHEXIS

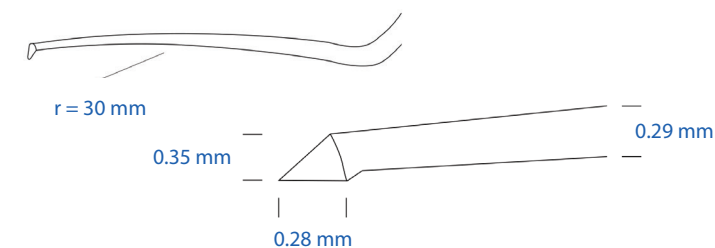

Capsulorhexis forceps straight ▪ SC30 ▪ RUC30 ▪ TIC30

Length: 80 mm
 Handle length: 56 mm
 50° angled platform notched tips 0.5 mm



CAPSULORHEXIS

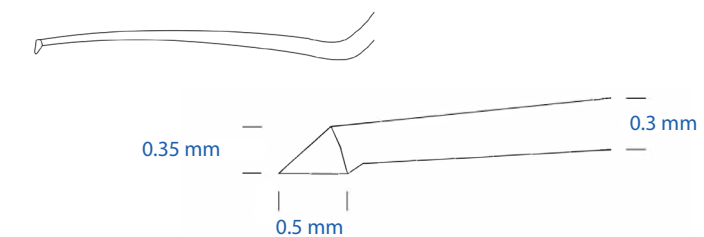

Capsulorhexis forceps straight • SC31 • RUC31 • TIC31

Length: 10.5 cm
 Handle length: 75 mm
 45° angled
 12 mm platform tips 0.3 mm



CAPSULORHEXIS

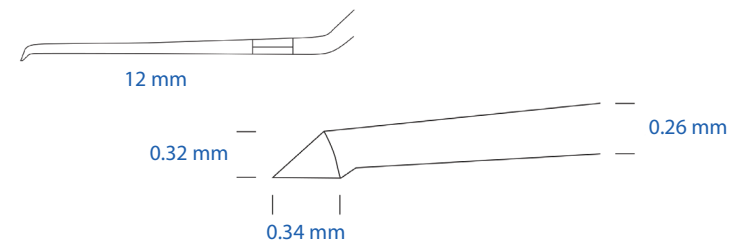

MICS Capsulorhexis forceps cross action • SC33M • RUC33M • TIC33M

Length: 11.5 cm
 Handle length: 84 mm
 50° angled
 2.2 mm incision



CAPSULORHEXIS

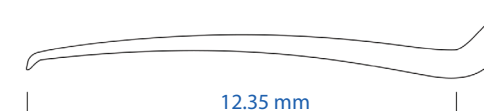

Capsulorhexis forceps curved • SC29 • RUC29 • TIC29

Length: 10.5 cm
 Handle length: 76 mm
 45° angled platform with notched tips 0.3 mm
 2.4 mm incision



CAPSULORHEXIS

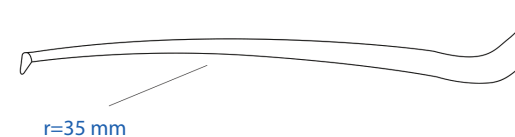

MICS Capsulorhexis forceps curved • SC29M • RUC29M • TIC29M

Length: 10.5 cm
 Handle length: 77 cm
 45° angle
 12 mm platform
 0.3 mm tips
 2.2 mm incision



CAPSULORHEXIS

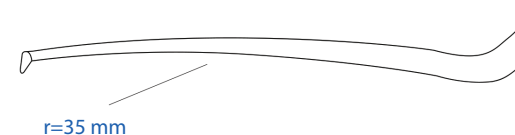

MICS Capsulorhexis forceps round bodied curved • SC34M • RUC34M • TIC34M

Length: 10.5 cm
 Handle length: 77 mm
 50° angle 0.2 mm tip
 12 mm platform
 2.2 mm incision



CAPSULORHEXIS

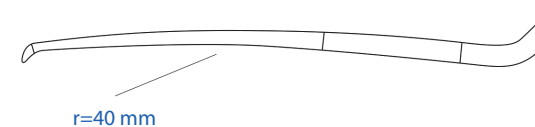

MICS Capsulorhexis forceps straight • SCM01 • RUCM01 • TICM01

Length: 10.5 cm
 Handle length: 76 mm
 45° angled 0.3 mm notched tips, with 11 mm platform
 2.2 mm incision



CAPSULORHEXIS



Adsons dissection forceps • SC59 • RUC59 • TIC59

Length: 12.5 cm
 Handle length: 97 mm
 1 into 2 teeth
 28 mm platform



FIXATION

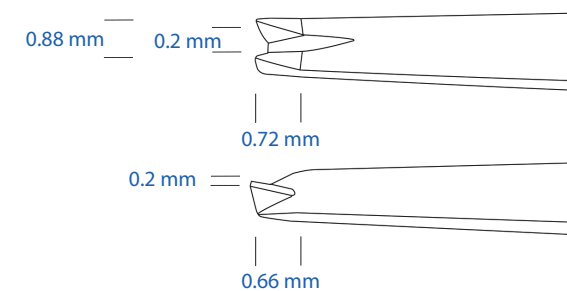

Bishops forceps • SC56 • RUC56 • TIC56

Length: 10.5 cm
 Handle length: 75 mm
 1 into 2 teeth
 5 mm platform
 30 mm tip



FIXATION

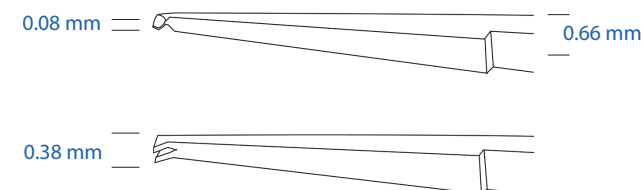

Bonn forceps • SC38 • RUC38 • TIC38

Length: 85 mm
 Handle length: 57 mm
 1 into 2 teeth 5 mm platform
 Short handle
 5 mm platform

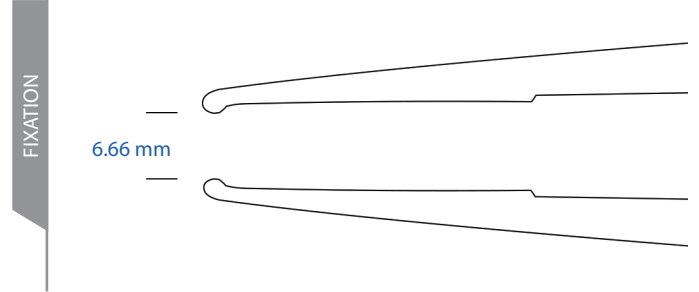

Bonn forceps • SC129 • RUC129 • TIC129

Length: 10.5 mm
 Handle length: 76 mm
 1 into 2 teeth 5 mm platform

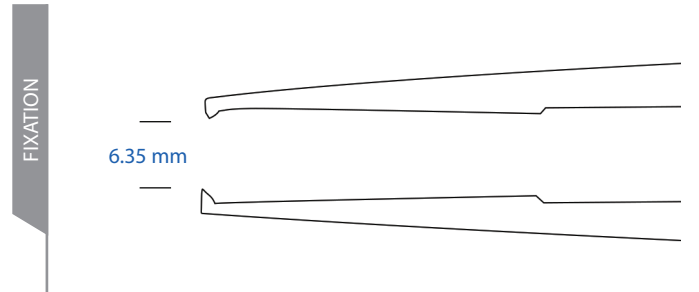

Colibri toothed forceps • SC22 • RUC22 • TIC20

Length: 11 cm
 Handle length: 72 mm
 55° angled
 1 into 2 teeth
 4 mm platform

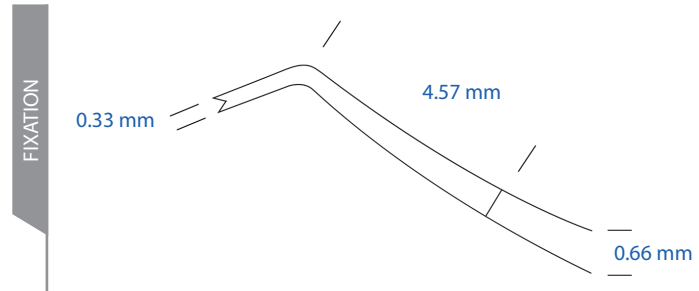

Colibri tying forceps • SC20 • RUC20 • TIC20

Length: 85 mm
 Handle length: 59 mm
 55° angle forked tip
 Short handle
 4 mm platform

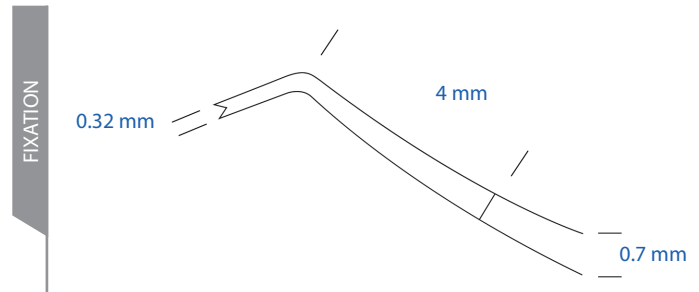

Fine claw forceps • SC115 • RUC115 • TIC115

Length: 10 cm
 Handle length: 68 mm
 2 into 1 teeth
 32 mm platform to tip



FIXATION

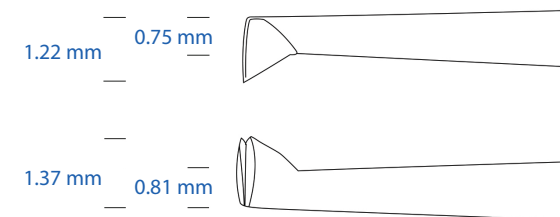

Hoskins forceps • SC55 • RUC55 • TIC55

Length: 85 mm
 Handle length: 56 mm
 Notched forceps
 5 mm platform

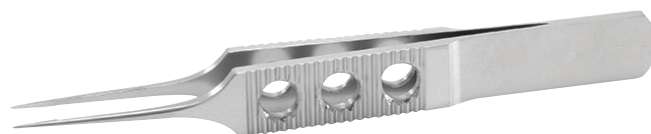

FIXATION

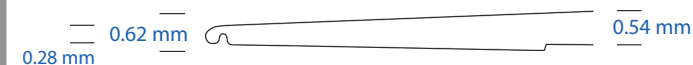

Iris forceps • SC116 • RUC116 • TIC116

Length: 10.5 cm
 Handle length: 67 mm
 1 into 2 teeth 5 mm platform



FIXATION

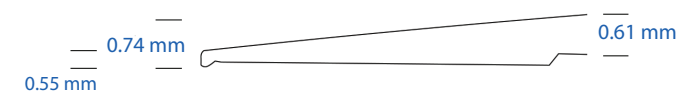

Iris forceps pointed • SC128 • RUC128 • TIC128

Length: 11 cm
 Handle length: 69 mm
 Serrated 15 mm platform



FIXATION

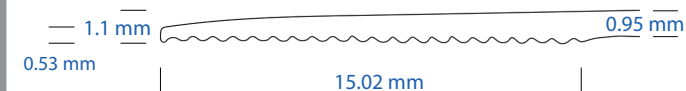

Jayles forceps • SC117 • RUC117 • TIC117

Length: 10.5 cm
 Handle length: 67 mm
 1 into 2 teeth 5 mm platform

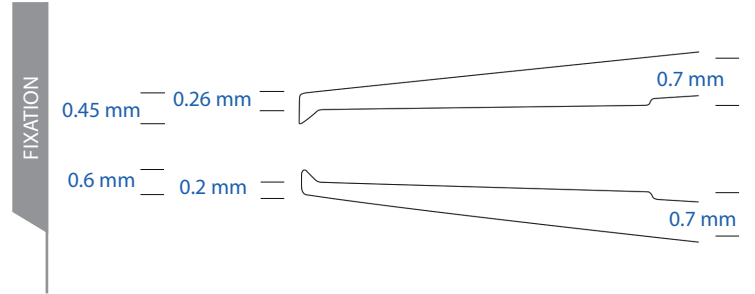

Straight notched forceps • SC49 • RUC49 • TIC49

Length: 11 cm
 Handle length: 76 mm
 Notched forceps
 5 mm platform

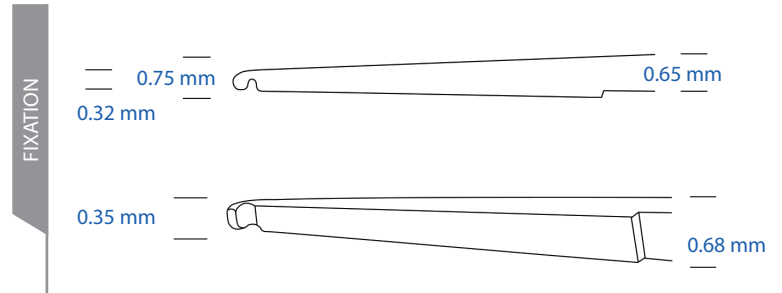

St. Martins forceps • SC54 • RUC54 • TIC54

Length: 84 mm
 Handle length: 56 mm
 1 into 2 teeth
 6 mm platform

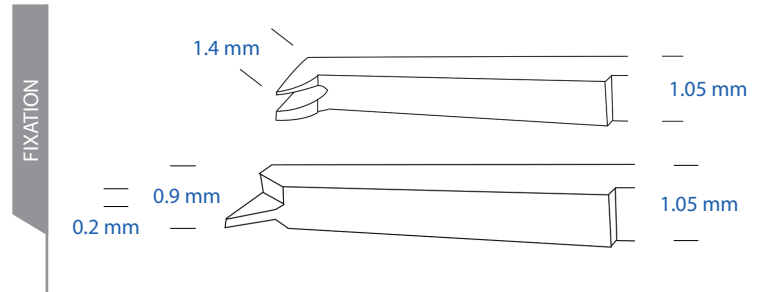
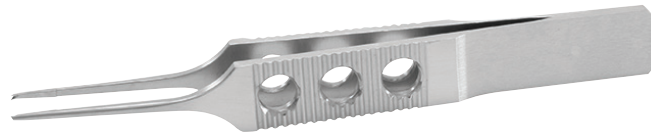

Straight toothed forceps fine • SC21 • RUC21 • TIC22

Length: 10.5 cm
 Handle length: 78 mm
 1 into 2 teeth 5 mm platform

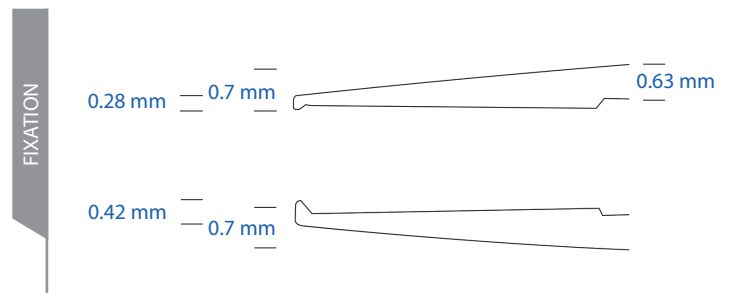

Adsons forceps • SC119 • RUC118 • TIC118

Length: 12.5 mm
 Handle length: 97 mm
 14 mm serrated platform



GENERAL

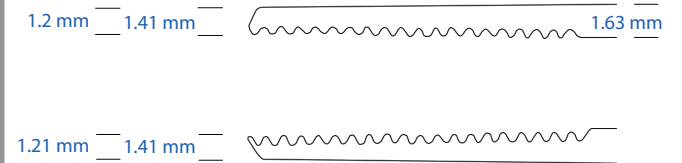

Adsons forceps fine serrated • SC113 • RUC113 • TIC113

Length: 12.5 cm
 Handle length: 88 mm
 serrated 14 mm tying platform
 32 mm platform

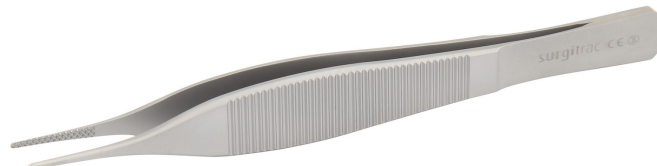

GENERAL

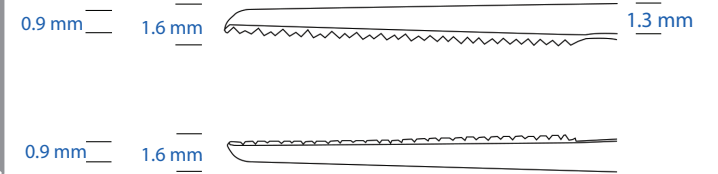

Denis sclerectomy forceps • SC104 • RUC104 • TIC104

Length: 10.5 cm
 Handle length: 75 mm
 30 mm platforms



GENERAL

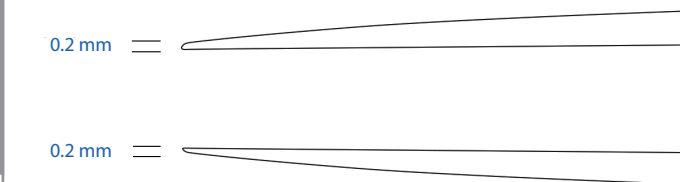

Epilation - Cilia forceps • SC58 • RUC58 • TIC58

Length: 73 mm
 Platform 50 mm



GENERAL

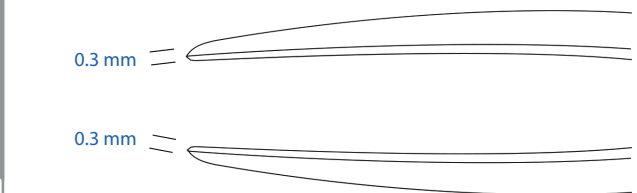

Epilation forceps • SC127 • RUC127 • TIC127

Length: 88 mm
18 mm platform

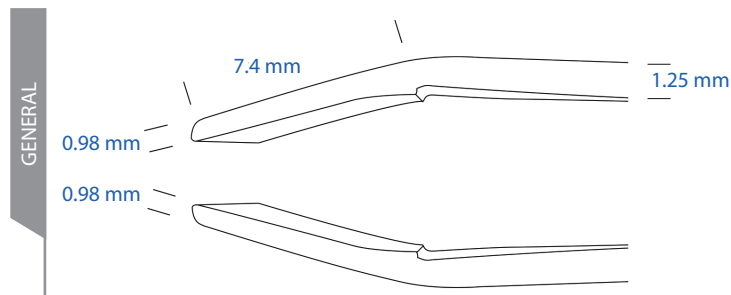

Jewellers forceps • SC60 • RUC75 • TIC75

Length: 11.5 cm
Handle length: 82 mm
0.1 mm fine pointed ends
32 mm platform

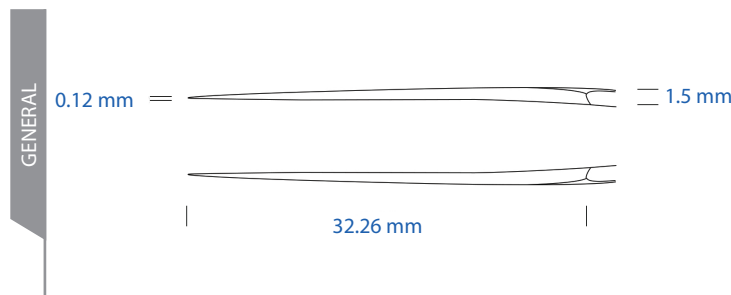

Moorfields forceps • SA12 • RUA12 • TIA12

Length: 11 cm
Handle length: 68 mm
Serrated 15 mm platform

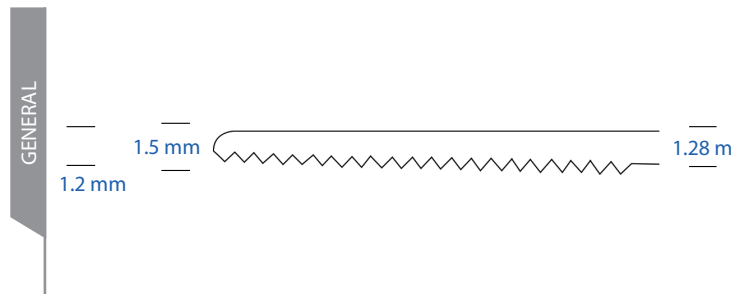

Moorfields forceps fine • SA17 • RUA17 • TIA17

Length: 11 cm
Handle length: 71 mm
Serrated 15 mm platform

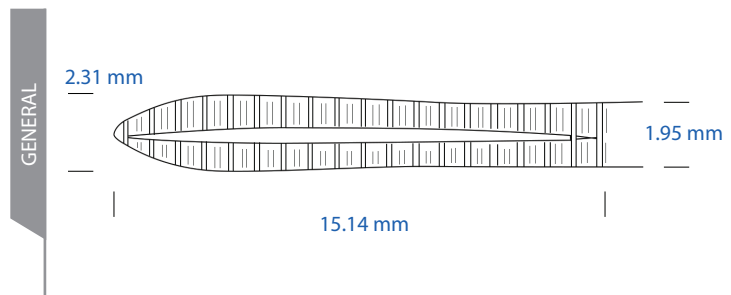

Mosquito forceps • SG02 • RUG02 • TIG02

Length: 13 cm
22 mm serrated clamp area



GENERAL

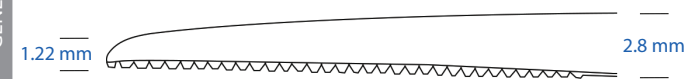

IOL removal forceps • SC112 • RUC112 • TIC112

Length: 82 mm
Handle length: 54 mm
35° angled serrated tips, with 13 mm platform



LENS

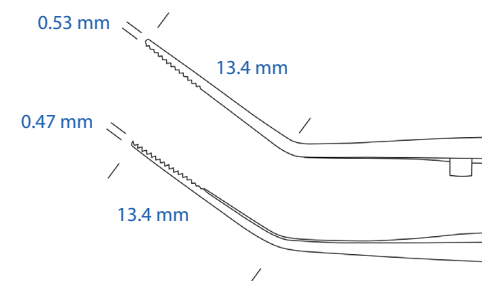

Lens folding forceps • SC51 • RUC51 • TIC51

Length: 10.5 cm
Handle length: 78 mm
45° angled, 1 cm platform



LENS

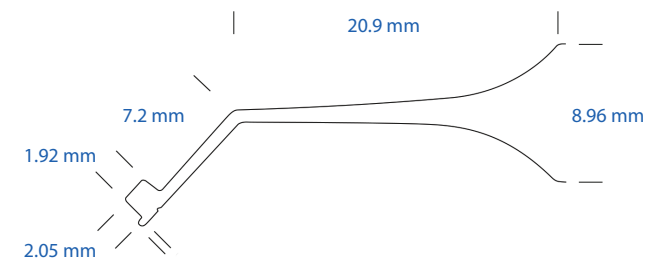

Lens implantation forceps • SC52 • RUC52 • TIC52

Length: 10.5 cm
Handle length: 76 mm
40° angled platform
10 mm platform



LENS

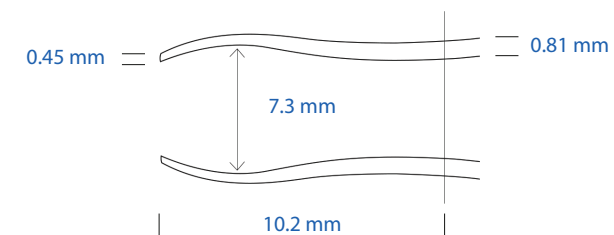

Kelman Mc Pherson forceps • SC73 • RUC73 • TIC73

Length: 83 mm
 Handle length: 57 mm
 50° angled 7 mm tying platforms

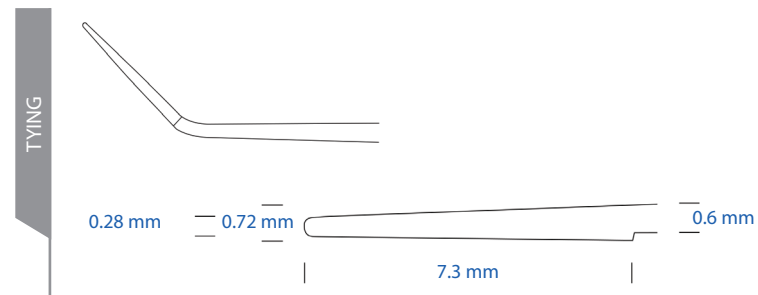
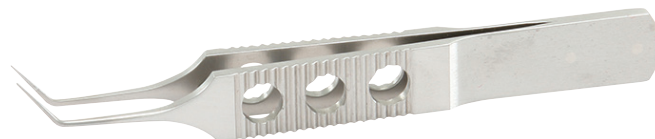

Mc Pherson tying forceps • SC72 • RUC72 • TIC72

Length: 10.5 cm
 Handle length: 76 mm
 45° angled 5 mm tying platforms

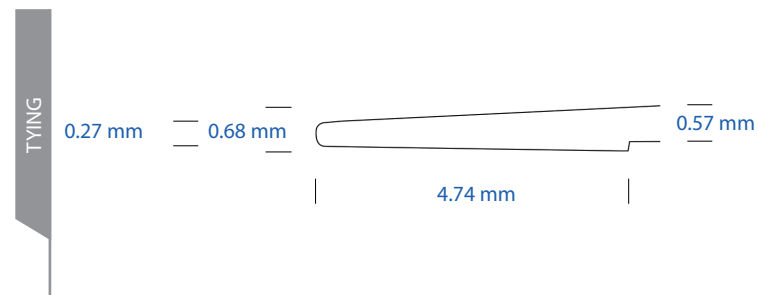

Curved notched forceps • SC50 • RUC50 • TIC50

Length: 10 cm
 Handle length: 76 mm
 Curved 5 mm tying platforms

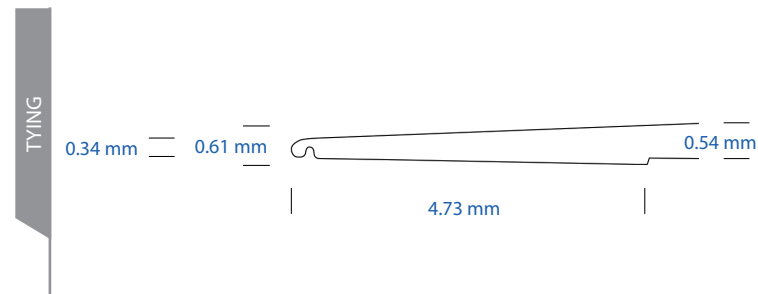

Straight tying forceps • SC19 • RUC19 • TIC19

Length: 85 mm
 Handle length: 56 mm
 5 mm tying platforms

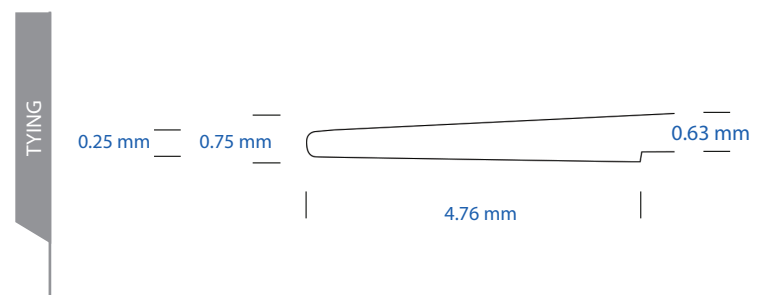

Suture removal forceps curved • SC120 • RUC120 • TIC120

Length: 10.5 cm
 Handle length: 76 mm
 Pointed tips, 5 mm tying platform

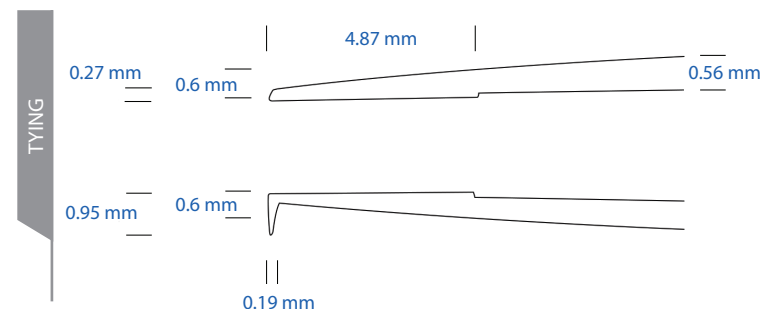

Troutman tying forceps curved • SC105 • RUC105 • TIC105

Length: 10.5 cm
 Handle length: 76 mm
 5 mm tying platform

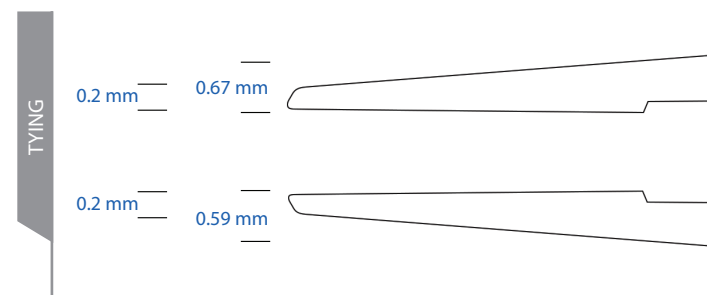

Straight tying forceps • SC71 • RUC71 • TIC71

5 mm platforms
 Length: 10.5 cm
 Handle length: 75 mm
 5 mm tying platform

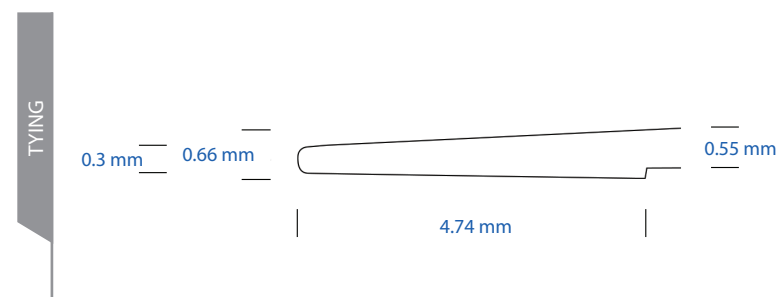

Manipulators and Choppers

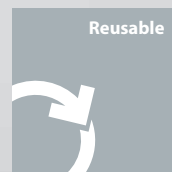
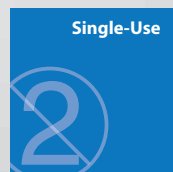

Single Use Instrument Code

Stainless Steel Reusable Instrument Code

Titanium Reusable Instrument Code

Chopper and dialler • SC39 • RUC39 • TIC39

Length: 12 cm
 Handle length: 76 mm
 45° angled ends, one rounded tip and one 1 mm Y shaped end
 Round bodied
 Double ended

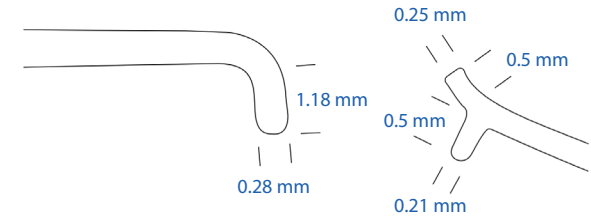

Drysdale nucleus spatula • SC47 • RUC47 • TIC47

Length: 11 cm
 Handle length: 85 mm
 45° angled paddle shaped tip
 Round bodied



Greens chopper • SC45 • RUC45 • TIC45

Length: 11.5 cm
 Handle length: 95 mm
 30° angled top curved rounded hook
 Round bodied

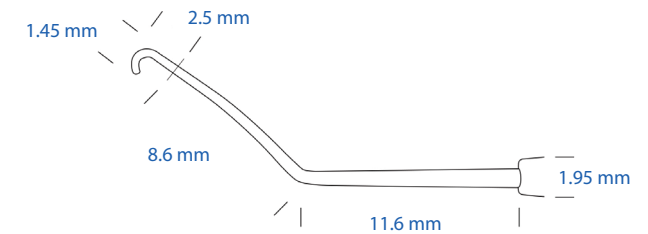

Govan manipulator • SC100 • RUC100 • TIC100

60° angle pointed tip
 Round bodied

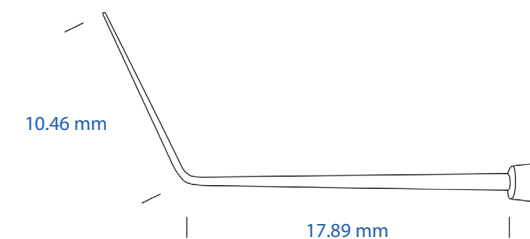

Govan manipulator and Phaco chopper - SC102 - RUC102 - TIC102

Length: 12 cm
 Handle length: 78 mm
 60° pointed end and 90° blunt end
 Round bodied
 Double ended

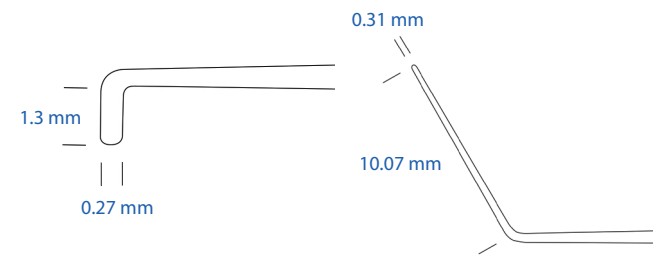

Iris reposer - SC63 - RUC63 - TIC63

Length: 13 cm
 Handle length: 98 mm



Jones chopper - SC90 - RUC90 - TIC90

Length: 12 cm
 Handle length: 95 mm
 45° angled pointed tip
 Round bodied

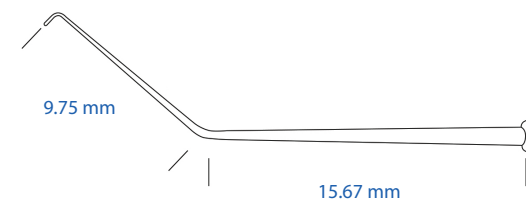

Koch chopper - SC44 - RUC44 - TIC44

Length: 12 cm
 Handle length: 95 mm
 45° angled 1 mm rounded tip
 Round bodied

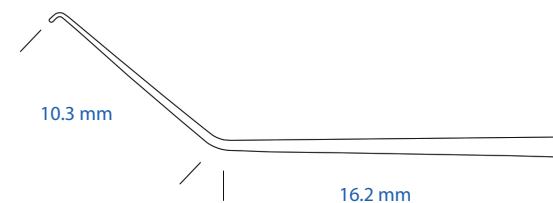

Koch phaco spatula • SC143 • RUC143 • TIC143

Length: 12 cm
 Handle length: 96 mm
 Slight curved spatula
 Round bodied

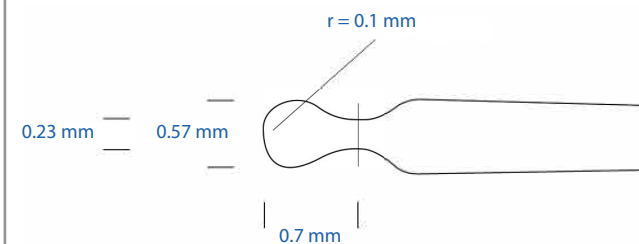

Kuglen hook • SG15 • RUG15 • TIC15

Length: 11.5 cm
 Handle length: 95 mm
 45° angled blunt, flat hooked tip
 Round bodied

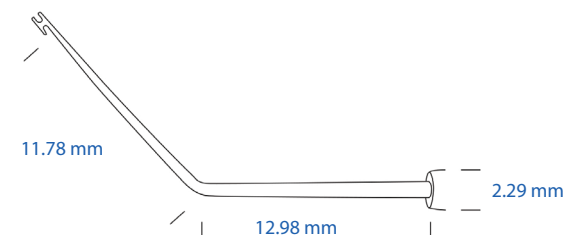

Le Buisson manipulator • SC106 • RUC106 • TIC106

Length: 11.5 cm
 Handle length: 90 mm
 Round bodied

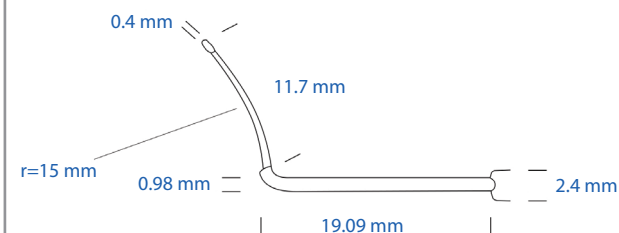

Lens dialer • SC46 • RUC46 • TIC46

Length: 12 cm
 Handle length: 95 mm
 35° angled
 Round bodied



Lester hook • SC146 • RUC146 • TIC146

Length: 11.5 cm
 Handle length: 10 cm
 Round bodied

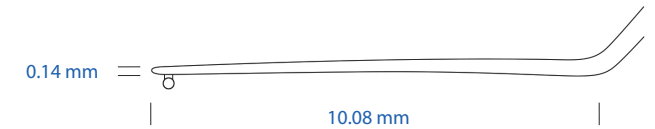

Phaco chopper and Mushroom manipulator double ended • SC147 • RUC147 • TIC147

Length: 12 cm
 Handle length: 70 mm
 45° chopper
 Round bodied
 Double ended

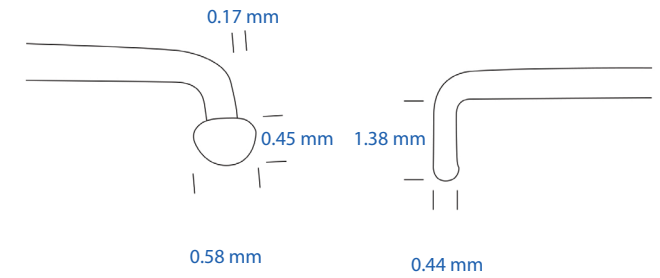

Phaco chopper • SC43 • RUC43 • TIC43

Length: 12 cm
 Handle length: 95 mm
 40° angled round end
 Round bodied

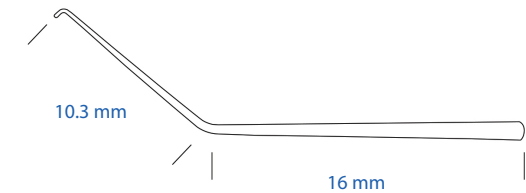

Phaco chopper claw • SC42 • RUC42 • TIC42

Length: 12 cm
 Handle length: 95 mm
 40° angled tip, hooked tip
 Round bodied

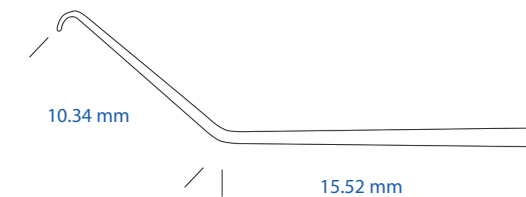

Pisacano rotator and Neuham manipulator double end • SC101 • RUC101 • TIC101

Length: 10 cm
 Handle length: 75 mm
 60° spatula end and 30° round end
 Round bodied
 Double ended



Sinsky hook and Govan manipulator double ended • SC144 • RUC144 • TIC144

Length: 12 cm
 Handle length: 76 mm
 60° manipulator and 45° hooked end
 Round bodied
 Double ended

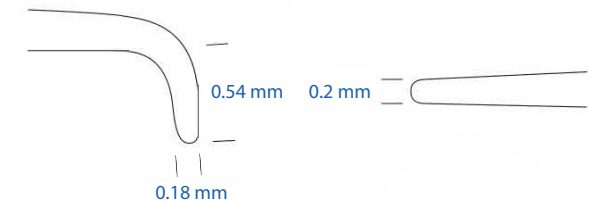
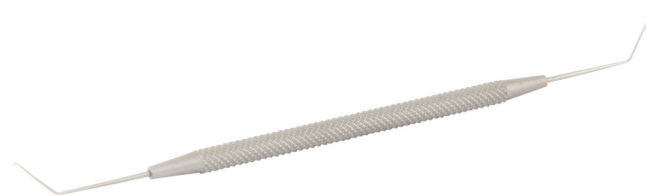

Mushroom nucleus manipulator • SC48 • RUC48 • TIC48

Length: 12 cm
 Handle length: 95 mm
 45° angled mushroom shaped tip
 Round bodied

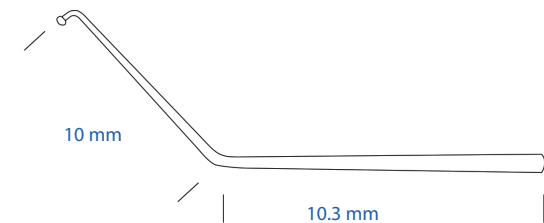

Y shaped Nucleus rotator • SC41 • RUC41 • TIC41

Length: 12 cm
 Handle length: 95 mm
 40° angled tip Y shaped end
 Round bodied

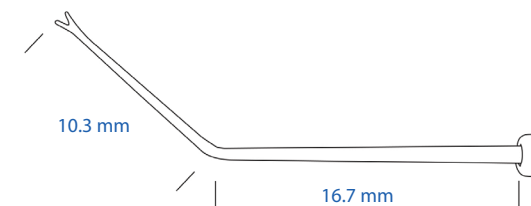

Speculums

Wire | Mechanical | Paediatric

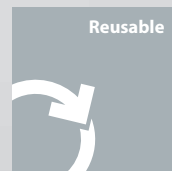
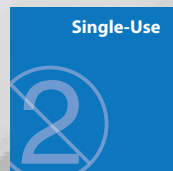
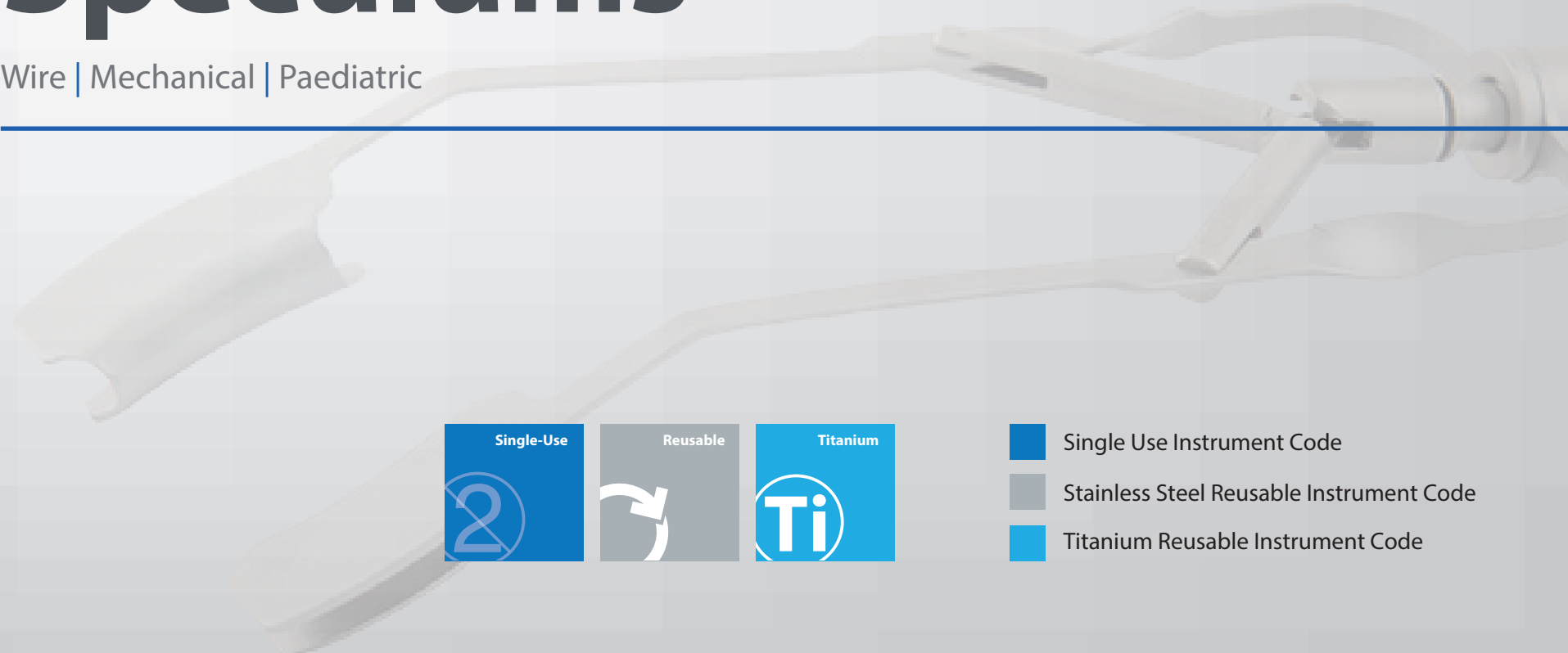

Single Use Instrument Code

Stainless Steel Reusable Instrument Code

Titanium Reusable Instrument Code

Broad gauge wire speculum • SC01 • RUC01 • TIC01

Length: 50 mm
Width: 40 mm

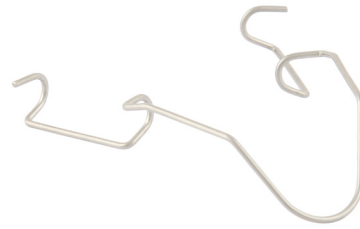

WIRE

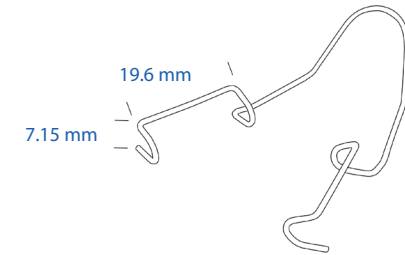

Closed loop wide speculum • SC07 • RUC07 • TIC07

Length: 44 mm
Width: 42 mm

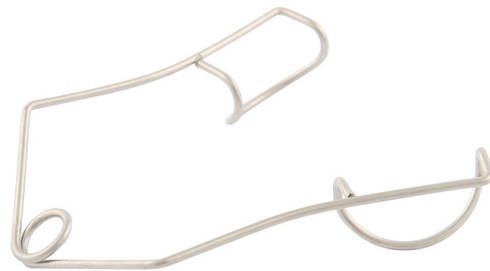

WIRE

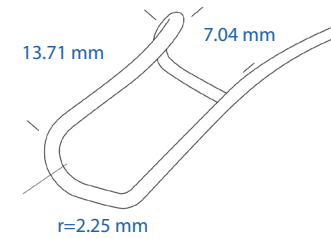

Heavy gauge wire speculum open loop • SC124 • RUC124 • TIC124

Length: 72 mm
Overall width: 58 mm

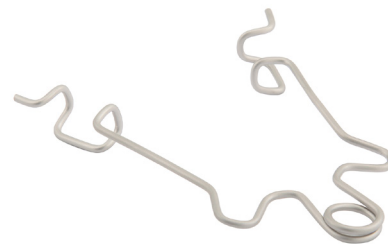

WIRE

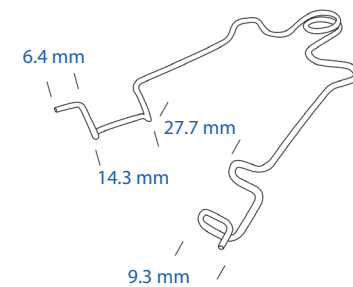

Kratz Barraquer closed loop • SC09 • RUC09 • TIC09

Length: 40 mm
Width: 42 mm

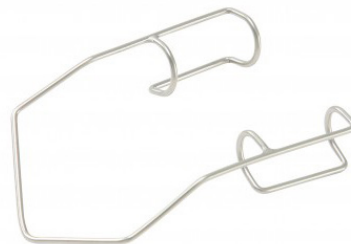

WIRE

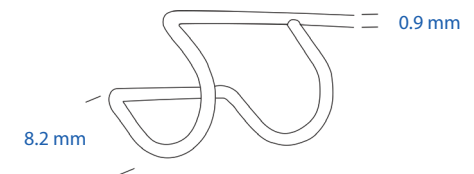

Kratz Barraquer closed loop speculum • SC132 • RUC132 • TIC132

Length: 43 mm
50° angle at base

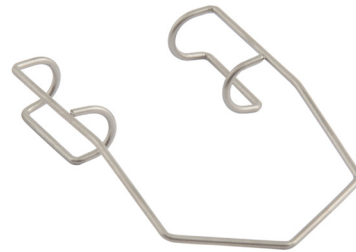

WIRE

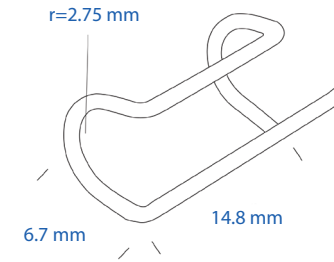

Kratz Barraquer wire speculum open loop • SC11 • RUC11 • TIC11

Length: 47 mm
Width: 31 mm
50° angle at base

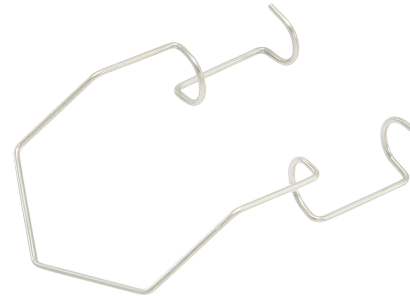

WIRE

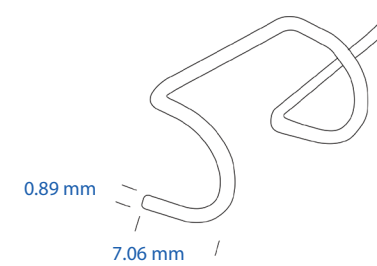

Kratz open loop wire speculum (blue) • SC107 • RUC107 • TIC107

Length: 44 mm
Overall width: 30 mm
50° angle at base

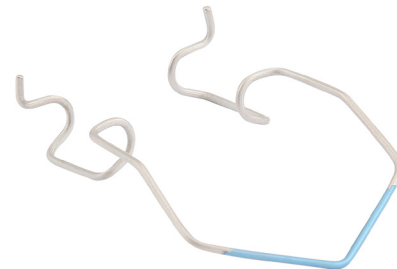

WIRE

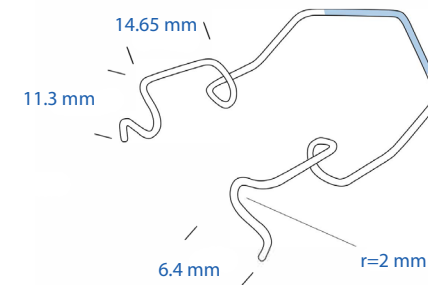

Kratz closed loop speculum • SC13 • RUC13 • TIC013

Length: 32 mm
50° angle at base

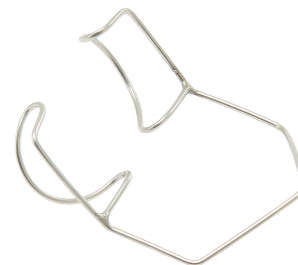

WIRE

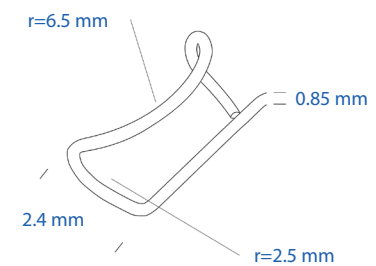

Kratz solid bladed wire speculum • SC05 • RUC05 • TIC05

Length: 42 mm
Width: 30 mm
65° angle at base



WIRE

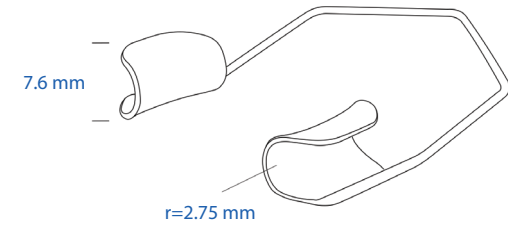

Plastic bladed wire speculum • SC11P

Single use only



WIRE

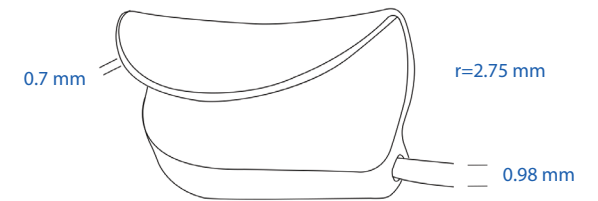

Temporal speculum • SC12 • RUC12 • TIC12

Length: 50 mm
Width: 42 mm

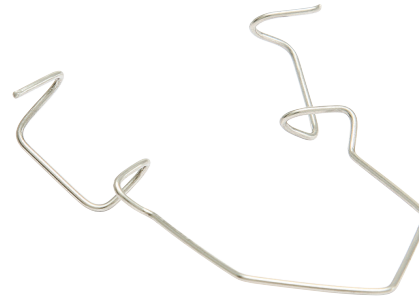

WIRE

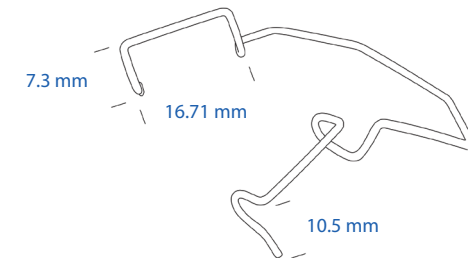

Bangerter adult speculum • SC03 • RUC03 • TIC03

Length: 50 mm
sliding screw adjustable
Blade length: 15 mm



MECHANICAL

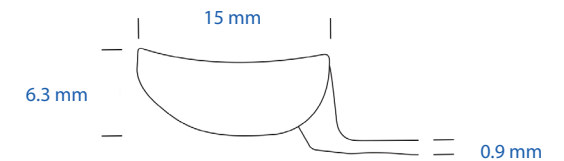

Bladed adjustable speculum • SR10 • RUR10 • TIC10

Length: 75 mm
Blade length: 15 mm



MECHANICAL

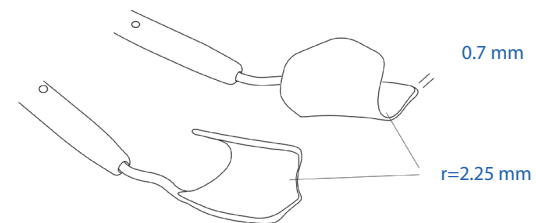

Clarke speculum • SC126 • RUC126 • TIC126

Length: 80 mm
Open loop: 12 mm



MECHANICAL

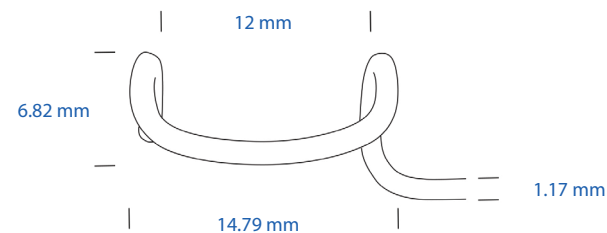

Kratz screw adjustable wire speculum open loop • SR11 • RUR01 • TIC11

Length: 78 mm
Blade length 15 mm



MECHANICAL

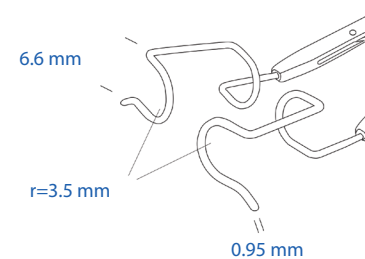

Solid bladed screw adjustable speculum • SC08 • RUC08 • TIC08

Length: 85 mm
Blade length: 14 mm



MECHANICAL

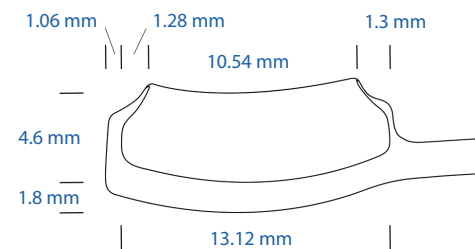

Kratz paediatric closed loop 10 mm speculum • SC10 • RUC10 • TIC10

Length: 29 mm
Width: 30 mm
10 mm



PAEDIATRIC

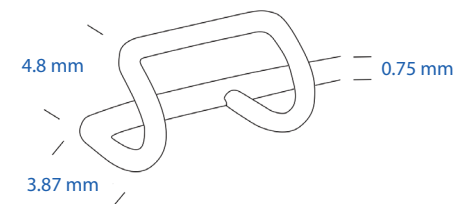

Neonate paediatric speculum • SC103 • RUC103 • TIC103

Length: 25 mm
Width: 20 mm
4 mm closed loop
80° angle at base



PAEDIATRIC

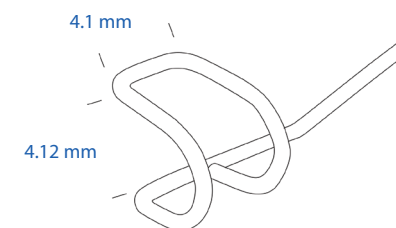

Neonate 4 mm speculum • SC15 • RUC15 • TIC15

Length: 25 mm
Width: 31 mm
20-30 mm adjustable
3 mm blade



PAEDIATRIC

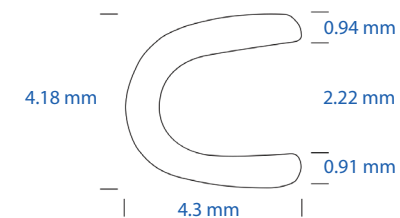

Paediatric 6 mm speculum • SC14 • RUC14 • TIC14

Length: 25 mm
Width: 35 mm
6 mm blade



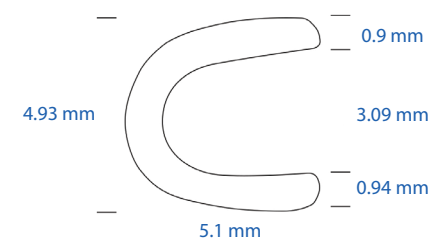

PAEDIATRIC

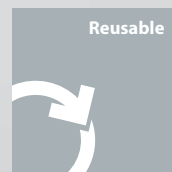
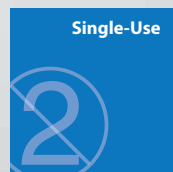
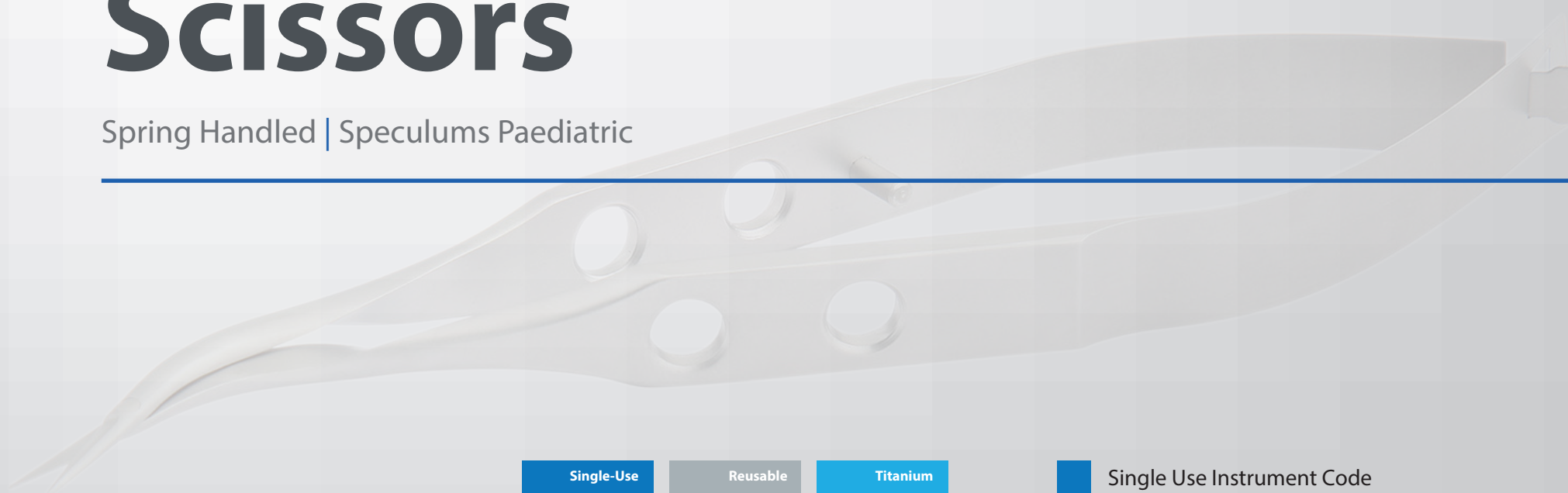

Scissors

Spring Handled | Speculums Paediatric



 Single Use Instrument Code

 Stainless Steel Reusable Instrument Code

 Titanium Reusable Instrument Code

Castroviejo corneal scissor right and left • SC82 • RUC82 • TIC83

Length: 10 cm
 Handle length: 75 mm
 ■ SC83 ■ RUC83 ■ TIC83 Castroviejo corneal scissor left
 8 mm blade



SPRING HANDLED

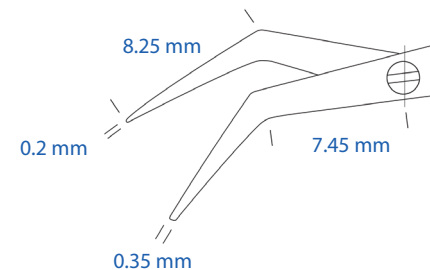

Castroviejo scissors straight & round • SC110 • RUC110 • TIC110

Length: 11 cm
 Handle: 65 cm
 11 mm blade



SPRING HANDLED

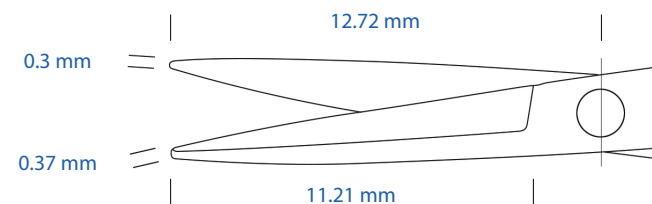

Ong iris scissor • SC80 • RUC80 • TIC80

Length: 88 mm
 Handle: 52 mm
 10 mm blade



SPRING HANDLED

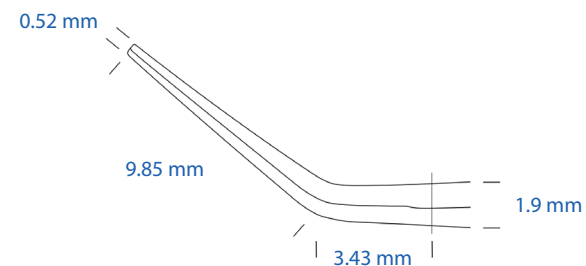

Osher scissors • SC109 • RUC109 • TIC109

Length: 95 mm
 Handle length: 61 mm
 Fine serrated cutting platform
 9 mm blade



SPRING HANDLED

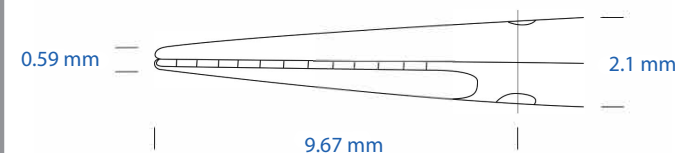

Stallard corneal scissors • SA13 • RUA13 • TIA13

Length: 12 cm
 Handle length: 67 mm
 Fine pointed ends
 40 mm blade



SPRING HANDLED

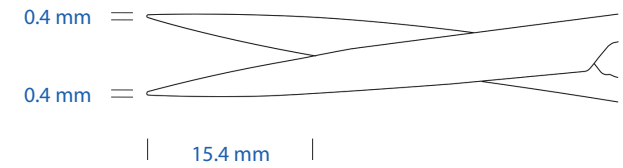

Vannas scissors • SC81 • RUC81 • TIC81

Length: 83 mm
 Handle length: 52 mm
 8 mm blade



SPRING HANDLED

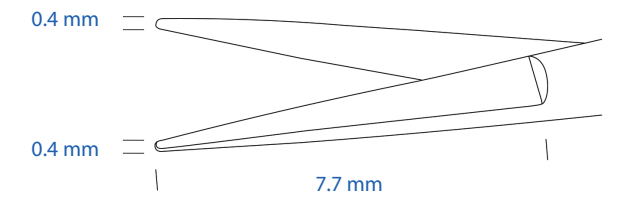

Vannas scissors curved • SC108 • RUC108 • TIC108

Length: 10 cm
 Handle length: 62 mm
 Sharp pointed end
 9 mm blade



SPRING HANDLED

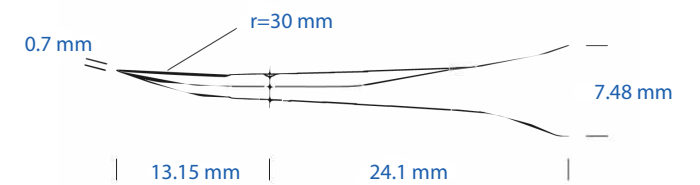

Westcott conjunctival scissors • SA11 • RUA11 • TIA11

Length: 11.5 cm
 Handle length: 79 mm
 12 mm blade



SPRING HANDLED

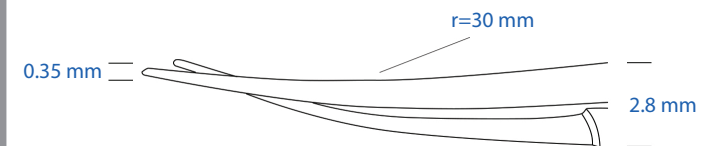

Wescott scissors dolphin nose • SA14 • RUA13 • TIA13

Length: 11.5 cm
Handle length: 67 mm
10 mm blade



SPRING HANDLED

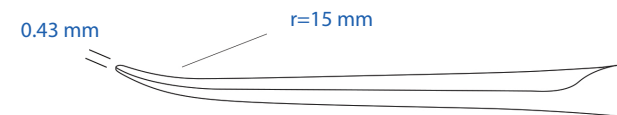

Castroviejo scissors straight • SC111 • RUC111 • TIC111

Length: 10 cm
Handle length: 63 mm
Straight tipped
60 mm blade



GENERAL

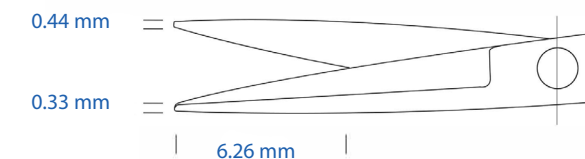

Dressing scissors • SG35 • RUG35 • TIG35

Length: 11.5 cm
Handle length: 26 mm
30 mm blade



GENERAL

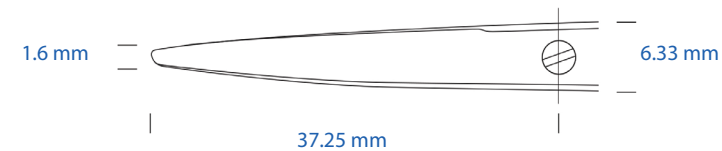

Enucleation scissors • SG34 • RUG34 • TIG34

Length: 25 mm
6 mm blade



GENERAL

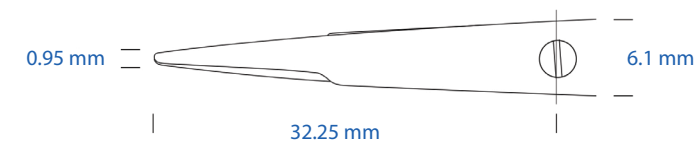

General long handle scissors blunt end • SG14 • RUG14 • TIG14

Length: 13 cm
Blunt round end
40 mm blade



GENERAL

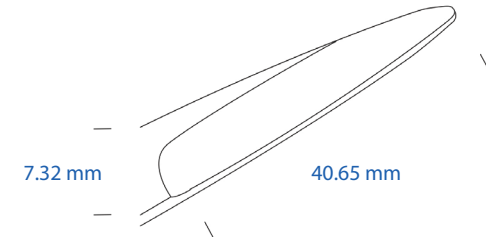

General scissors blunt end • SG06 • RUG06 • TIC06

Length: 89 mm
Blunt end
24 mm blade



GENERAL

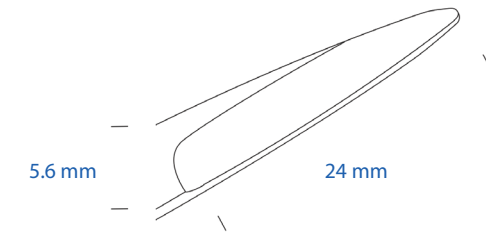

General scissors sharp pointed • SG01 • RUG01 • TIG01

Length: 88 mm
Sharp pointed end
22 mm blade



GENERAL

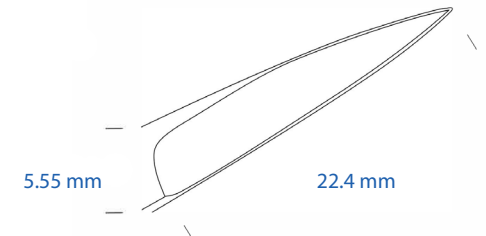

Metzenbaum scissors curved pointed • SG30 • RUG30 • TIG30

Length: 11cm
35 mm blade



GENERAL

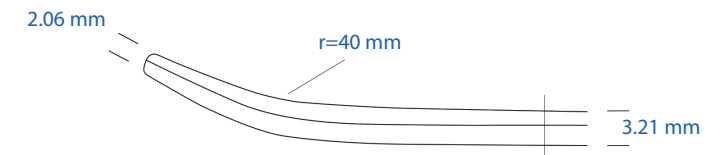

Strabismus scissors ■ SG07 ■ RUG07 ■ TIG07

Length: 11.5 cm
Blunt end
38 mm blade

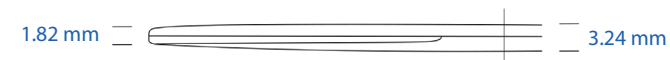

GENERAL

**Stevens scissors curved** ■ SG23 ■ RUG31 ■ TIG31

Length: 11.5 cm
38 mm blade



GENERAL

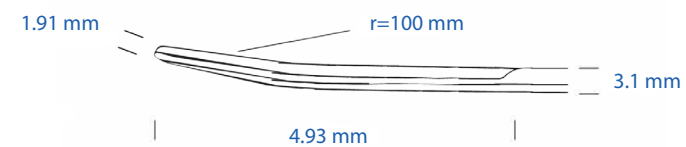

General ophthalmic

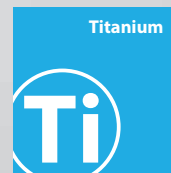
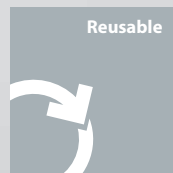
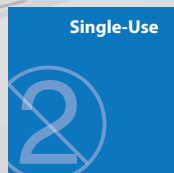

Single Use Instrument Code

Stainless Steel Reusable Instrument Code

Titanium Reusable Instrument Code

Ball tip muscle hook • SG32 • RUG32 • TIG32

Length: 10.5 cm
Handle length: 76 mm

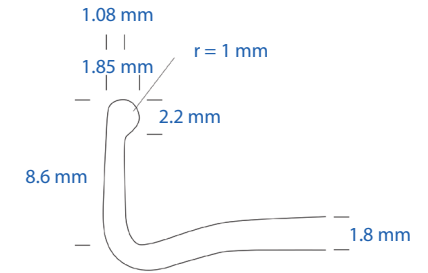

Bulldog clip • SG92 • RUG92 • TIG92

Length: 40 mm
Handle length: 25 mm
16 mm clipping platform not on website

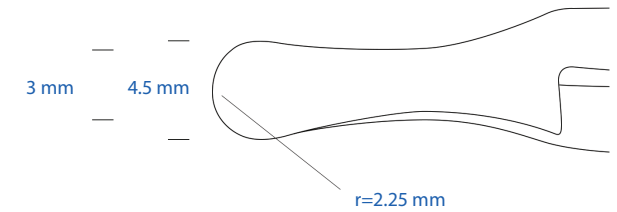

Chavasse hook • SC91 • RUC91 • TIC91

Length: 13 cm
Handle length: 98 mm
90° angle, curved hooked tip

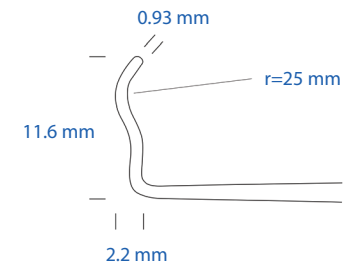

Desmarres retractor • SG20 • RUG20 • TIG20

Length: 14 cm
Handle length: 10 cm

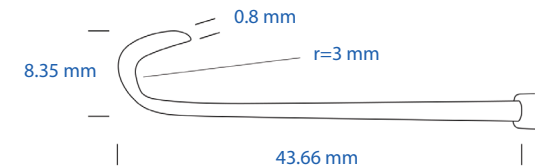

Eyelid plate • SG17 • RUG17 • TIG17

Length: 90 mm
27 mm end
17 mm end

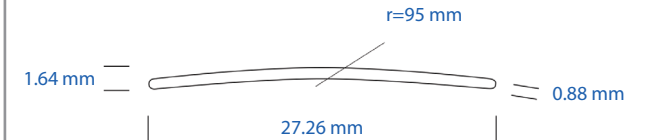

Guthrie hook • SG37 • RUG37 • TIG37

Length: 12 cm
Handle length: 90 mm
Two pronged hook

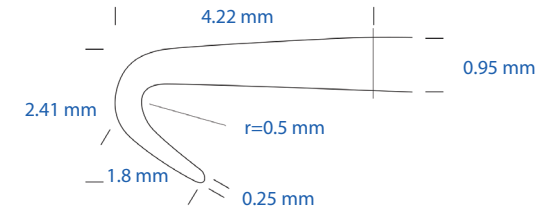

Halstead mosquito forceps straight • SG33 • RUG33 • TIG33

Length: 12.5 cm

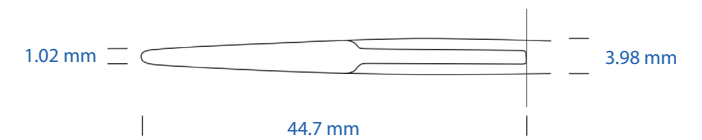

Jameson strabismus hook 5 mm • SG10 • RUG10 • TIG10

Length: 11 cm
Handle length: 83 mm
60° hook with rounded bulbous tip
• SG11 • RUG11 • TIG11 extended version 8 mm hook

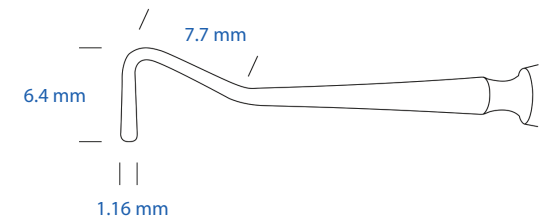

Mosquito forceps curved • SG22 • RUG22 • TIG22

Length: 12.5 cm
22 mm serrated clamp area

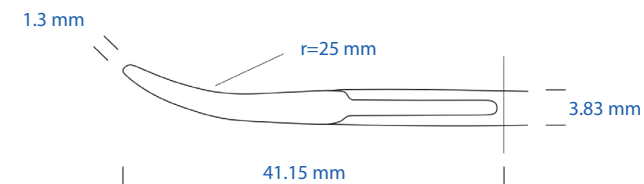

Scleral depressor bulbous end • SC23 • RUC23 • TIC23

Length: 13 cm
Handle length: 92 mm
2.5 mm 10° angled bulbous end



Scleral depressor double ended • SC25 • RUC25 • TIC25

Length: 13.5 cm
Handle length: 60 mm
6 mm, 2 mm hammer end,
2.5 mm 10° angled bulbous end
Double ended

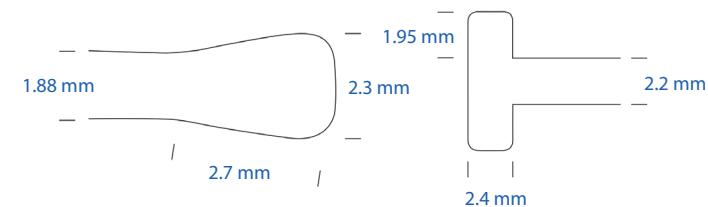

Scleral depressor hammer end • SC24 • RUC24 • TIC24

Length: 12.5 cm
Handle length: 92 mm
6 mm hammer, 2 mm ends

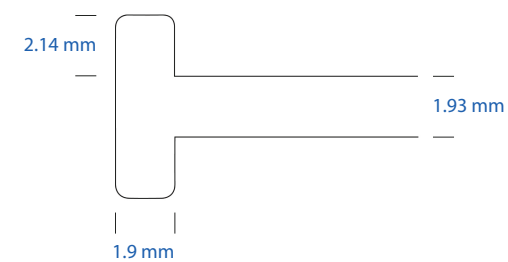

Thornton fixation ring small 13 mm • SG12 • RUG12 • TIG12

Length: 13 cm
Handle length: 91 mm
swivel head 11 mm cut out

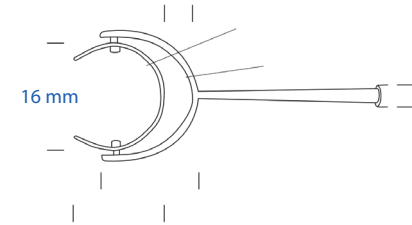

Thornton fixation ring standard 16 mm • SG13 • RUG13 • TIG13

Length: 13.5 cm
Handle length: 91 mm
swivel head 14 mm cut out

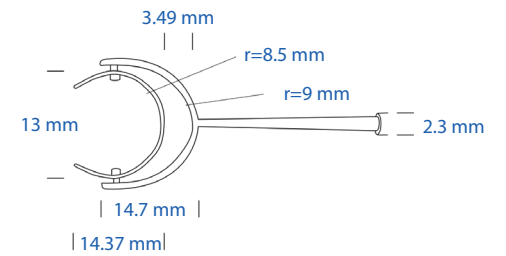



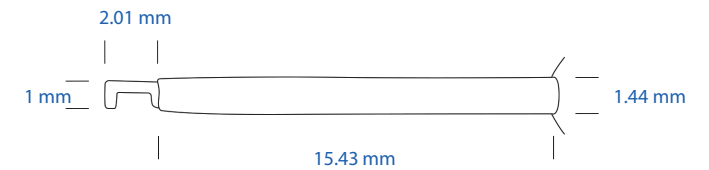

Trabeculectomy punch • SG03 • RUG03

Length: 12 cm
Handle length: 90 mm

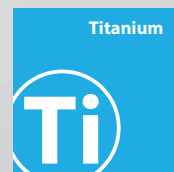
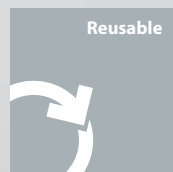
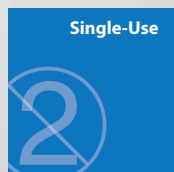
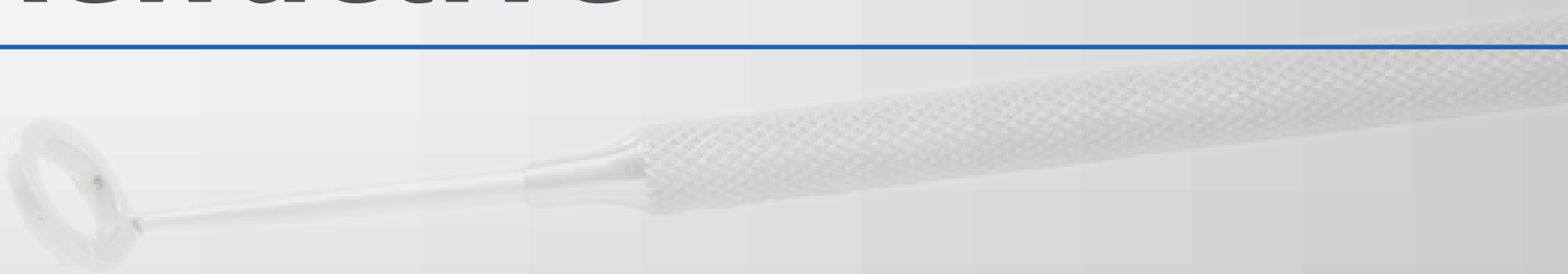

Corneal and Refractive



-  Single Use Instrument Code
-  Stainless Steel Reusable Instrument Code
-  Titanium Reusable Instrument Code

Bernheim hook D SAEK ▪ SR109 ▪ RUR109 ▪ TIR109

Length: 12 cm
Handle length: 95 mm

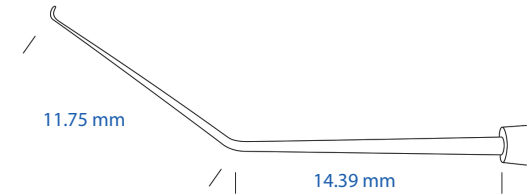

Corneal epithelium spatula round ▪ SR100 ▪ RUR100 ▪ TIR100

Length: 11 cm
Handle length: 85 mm

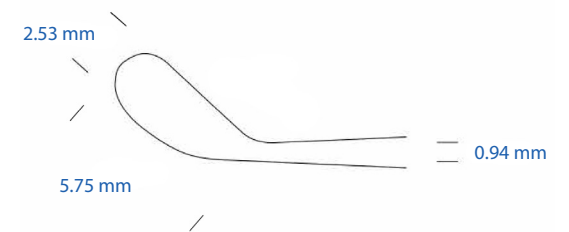

CK Lasik marker ▪ SR40 ▪ RUR40 ▪ TIR40

Length: 10 cm
Handle length: 76 mm
facilitate marking of the cornea
Round bodied

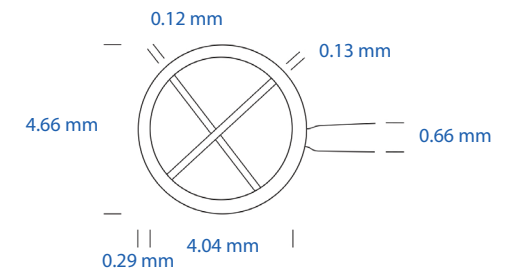

Epi peeler ▪ SR51 ▪ RUR51 ▪ TIR51

Length: 11 cm
Handle length: 95 mm
Manipulate epithelium during surgery

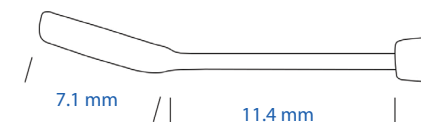

Epi peeler rectangle shaped ▪ SR61 ▪ RUR61 ▪ TIR61

Length 11 cm
Handle length 95 mm



Epi peeler D shaped ▪ SR60 ▪ RUR60 ▪ TIR60

Length 11 cm
Handle length 95 mm

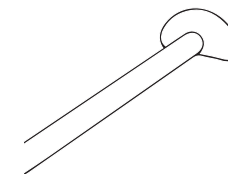

Intra Lasik flap separator ▪ SR34 ▪ RUR34 ▪ TIR34

Length: 12 cm
Round bodied

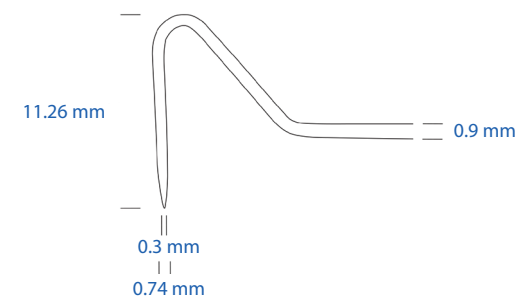

Kocaba DMEK forceps ▪ SR102 ▪ RUR102 ▪ TIR103

Length: 86 mm
Handle length: 56 mm

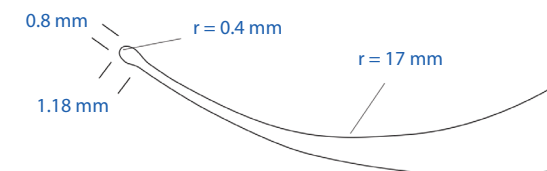

Alcohol well various sizes • SR41 • RUR41 • TIR41

Length: 12.5 cm
 Handle length: 92 mm
 Liquid holding well for alcohol application
 Round bodied

- SR41 • RUR41 • TIR41 9 mm
- SR42 • RUR42 • TIR42 8 mm
- SR43 • RUR43 • TIR43 7 mm

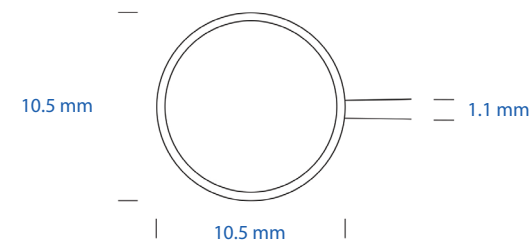

Lasik corneal marker • SR21 • RUR21 • TIR21

Length: 12 cm
 Handle length: 91 mm
 Y shaped forked marker

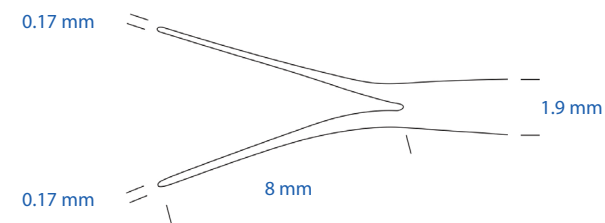

Lasik Flap elevator • SR31 • RUR31 • TIR31

Length: 12 cm
 Handle length: 95 mm
 45° angled, 12 mm tip with 0.1 mm rounded end

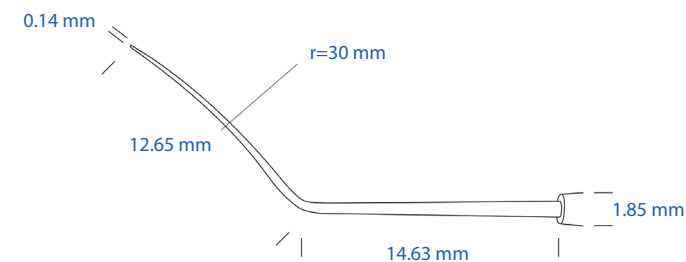

Lasik flap forceps • SR71 • RUR71 • TIR71

Length: 10 cm
 Handle length: 77 mm
 40° angled platform, circular 1 mm tips

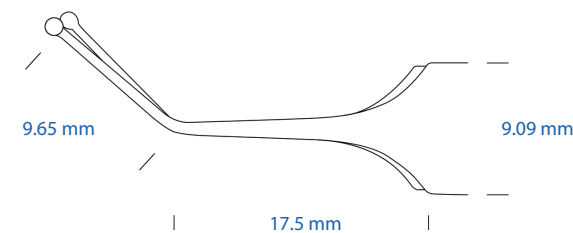

Lasik flap separator and elevator double end ▪ SR103 ▪ RUR103 ▪ TIR103

Length: 12 cm
 Handle length: 70 mm
 45° and 65° ends
 Double ended

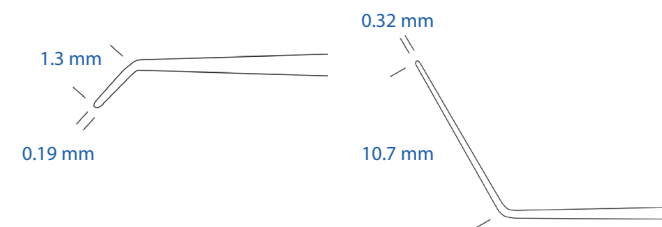

Lenticule separator hook and spatula double end ▪ SR104 ▪ RUR104 ▪ TIR104

Double ended

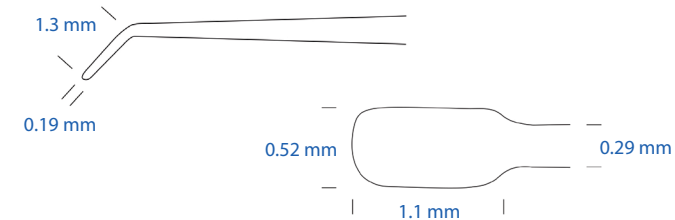

S Marker ▪ SR101 ▪ RUR101 ▪ TIR101

Length: 11 cm
 Handle length: 90 mm
 45° angle 2 mm marking end

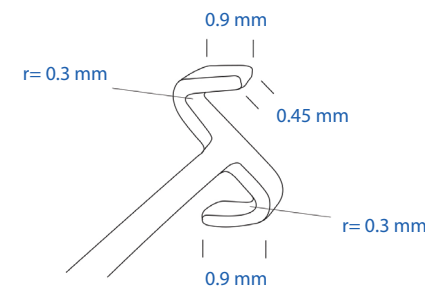

Trephine various sizes ▪ SR105 ▪ RUR105 ▪ TIR105

- SR105 ▪ RUR105 ▪ TIR105 17 mm
- SR106 ▪ RUR106 ▪ TIR106 18 mm
- SR107 ▪ RUR107 ▪ TIR107 19 mm



Measurers and Markers

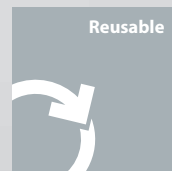
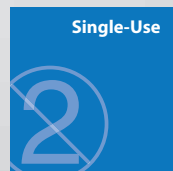

Single Use Instrument Code

Stainless Steel Reusable Instrument Code

Titanium Reusable Instrument Code

Braunstein caliper plastic • SG04P

Single use only

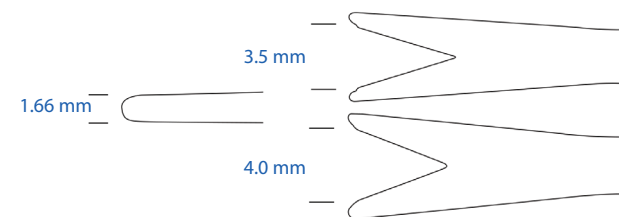

Braunstein fixed caliper 1.8 mm thickness • SG04 • RUG04 • TIG04

Length: 68 mm

3.5 mm 4 mm measure

(Available in other thicknesses of metal, please contact us for details)

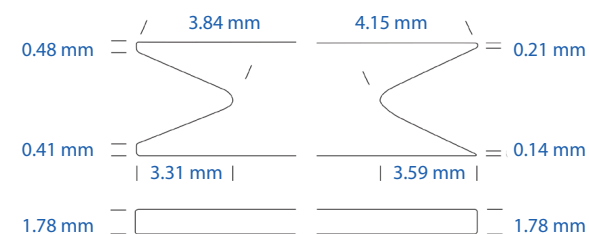

Castroviejo adjustable caliper • SG05 • RUG05 • TIG05

Length: 85 mm

20 mm measure

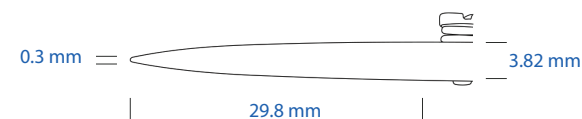

Corneal marker capsulorhexis guide • SC130 • RUC130 • TIC130

Length: 12 cm

Handle length: 92 mm

6 mm well

Round bodied

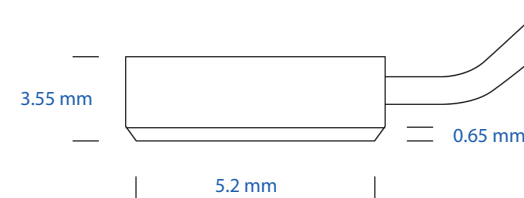
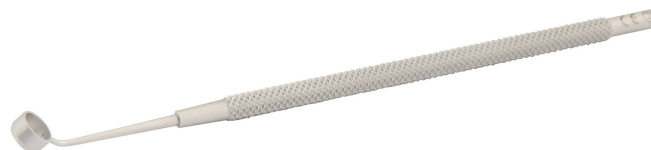

Injection marker - SC64

Length: 70 mm
 Handle length: 58 mm
 plastic marking end
 Single use only

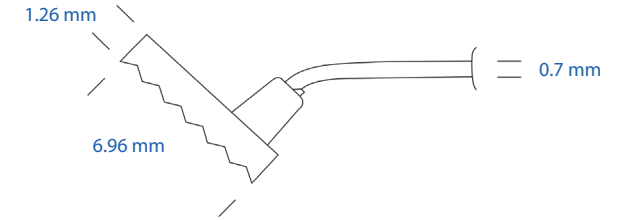

Mendez Gauge - SC65 - RUC65 - TIC65

Length: 12 cm
 Handle length: 80 mm
 180° circular marker

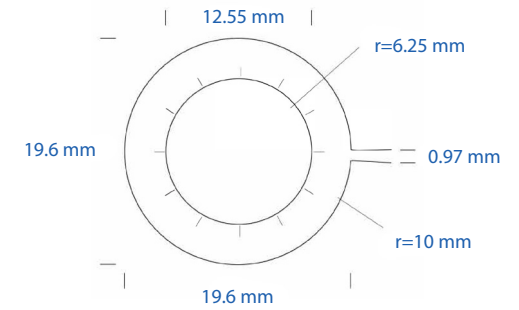

Scleral marker round bodied double ended - SG19 - RUG19 - TIG19

4.5 and 3.5 mm marking ends
 Length: 11 cm
 Handle: 60 mm
 Round bodied
 Double ended

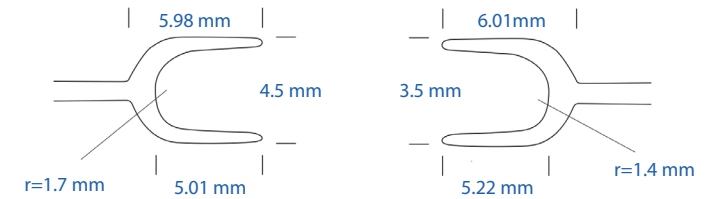

Curettes and Clamps

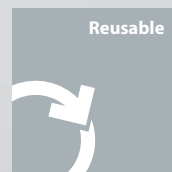
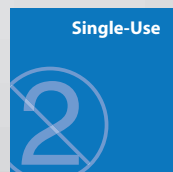
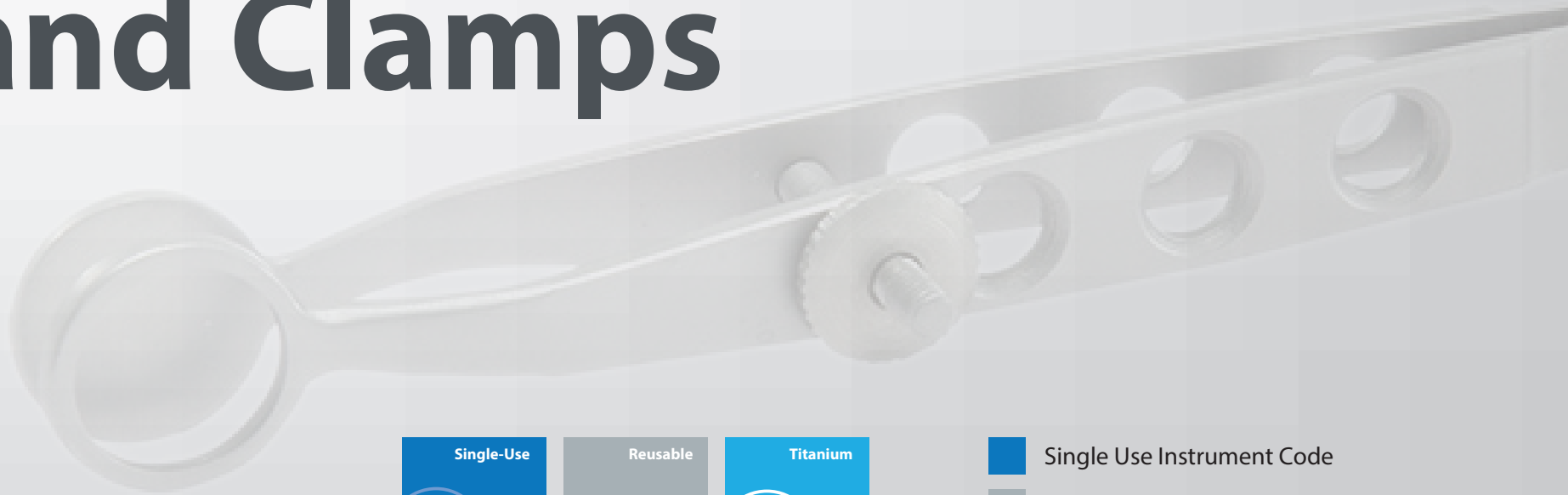

Single Use Instrument Code

Stainless Steel Reusable Instrument Code

Titanium Reusable Instrument Code

Curette various sizes - CR01 - RUCR01 - TICR01

Length: 11 cm
 Handle length: 80 mm

- CR01 ■ RUCR01 ■ TICR01 Curette small
- CR02 ■ RUCR02 ■ TICR02 Curette medium, 2.5 mm diameter chalazion curette
- CR03 ■ RUCR03 ■ TICR03 Curette large, 4 mm oval shaped chalazion curette



CURETTES

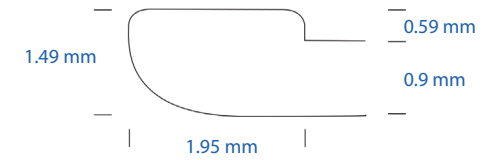

Curette double ended - CR05 - RUCR05 - TICR05

Length: 13m
 Handle length: 65 mm
 chalazion curette 2.5 mm diameter end and oval end



CURETTES

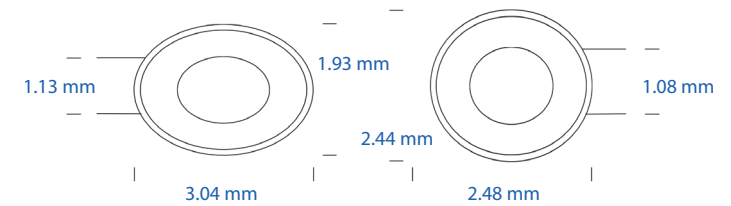

Chalazion clamp small - CS01 - RUCS01 - TICS01

Length: 11.5 cm
 Handle length: 82 mm
 12 mm diameter plate



CLAMPS

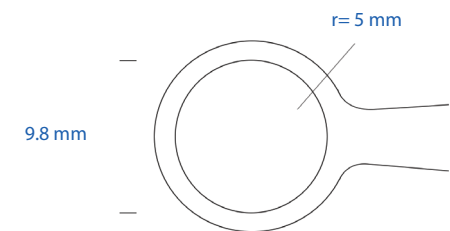

Chalazion clamp large - CS02 - RUCS02 - TICS02

Length: 85 mm
 Handle length: 53 mm
 21 mm diameter oval plate



CLAMPS

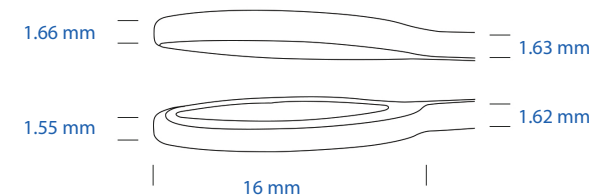

Needle holders

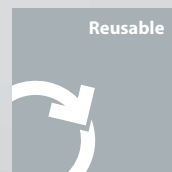
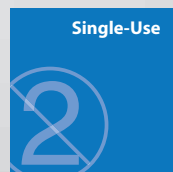

Single Use Instrument Code

Stainless Steel Reusable Instrument Code

Titanium Reusable Instrument Code

Barraquer needle holder curved • SC142 • RUC142 • TIC142

Length: 11.5 cm
 Handle length: 82 mm
 12 mm diameter plate
 Round bodied

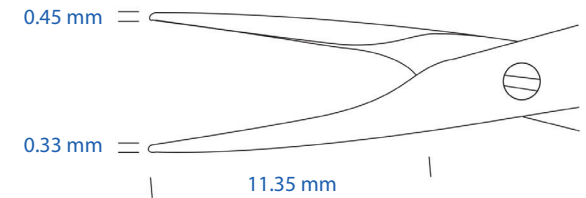

Castroviejo needle holder locking • SC118 • RUC118 • TIC118

Length: 14 cm

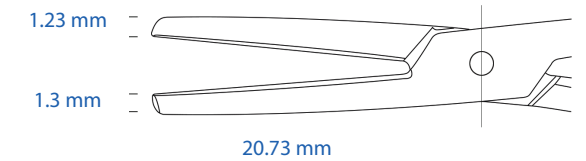

Needle holder blunt lock • SC62 • RUC62 • TIC62

Length: 13.5 cm
 Handle length: 82 mm

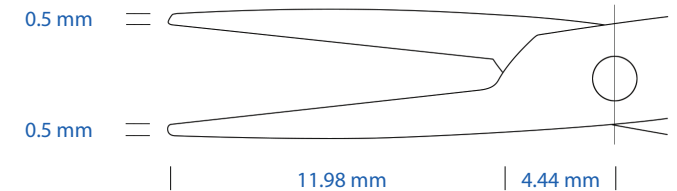

Needle holder curved • SC114 • RUC114 • TIC114

Length: 10 cm
 Handle length: 75 mm

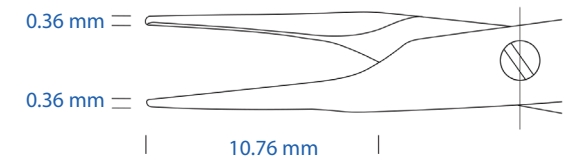

Suture needle holder curved • SC61 • RUC61 • TIC61

Length: 13.5 mm
 Handle length: 86 mm
 6 mm jaw

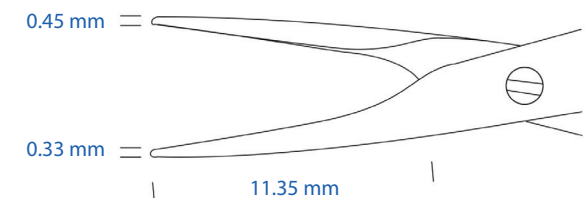

Lacrimal

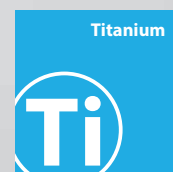
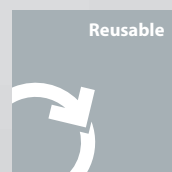
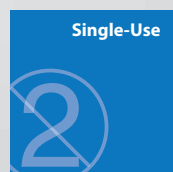
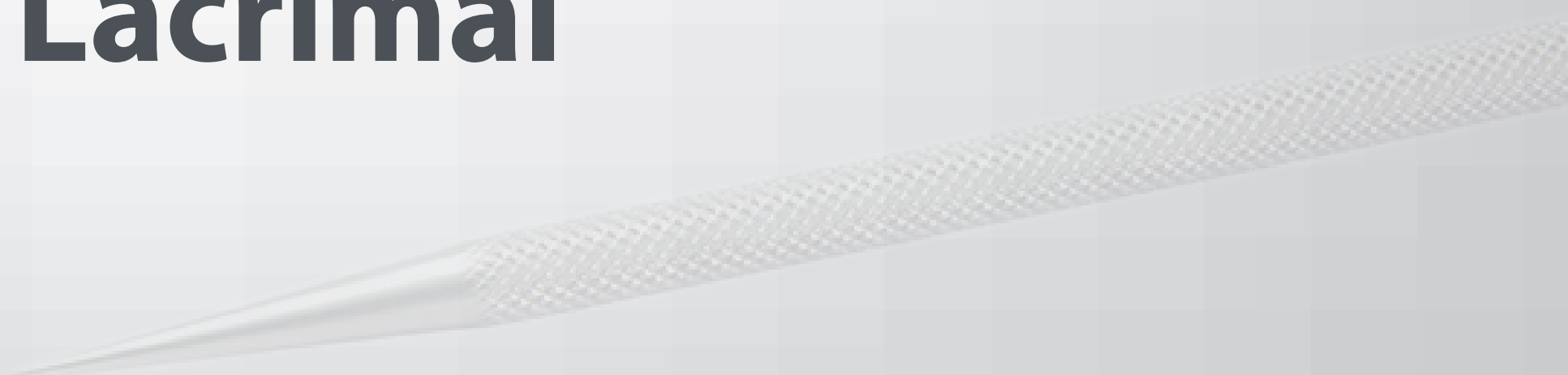

Single Use Instrument Code

Stainless Steel Reusable Instrument Code

Titanium Reusable Instrument Code

Bowmans Probe size 00-0 double ended • PD05 • RUPD05 • TIPD05

Length: 50 mm
Handle length: 30 mm

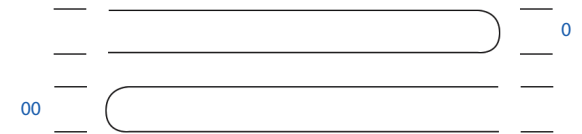

Bowmans Probe size 000-00 double ended • PD06 • RUPD06 • TIPD06

Length: 50 mm
Handle length: 30 mm

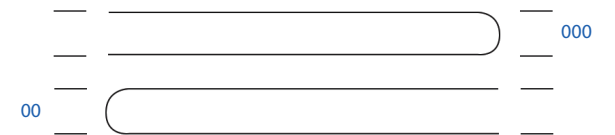

Lacrimal probe • PD08 • RUPD08 • TIPD08

Length: 95 mm
Handle length: 15 mm
0.5 mm pointed end



Punctal dilator blunt • PD02 • RUPD02 • TIPD02

Length: 95 mm
Handle length: 80 mm
0.4 mm pointed sharp end
Round bodied

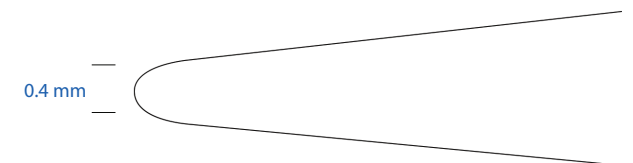

Punctal dilator double ended ▪ PD03 ▪ RUPD03 ▪ TIPD03

Length: 11.5 cm
 Handle length: 85 mm
 0.4 and 0.3 mm sharp pointed ends
 Round bodied

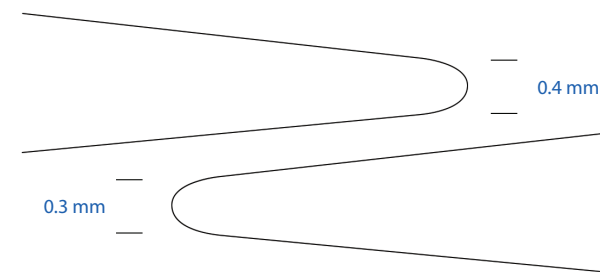

Punctal dilator sharp ▪ PD01 ▪ RUPD01 ▪ TIPD01

Length: 95 mm
 Handle length: 78 mm
 0.2 mm pointed sharp end
 Round bodied

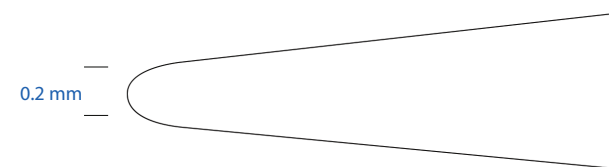

Punctal dilator short ▪ PD04 ▪ RUPD04 ▪ TIPD04

Length: 50 mm
 Handle length: 30 mm
 0.3 mm sharp pointed ends
 Round bodied

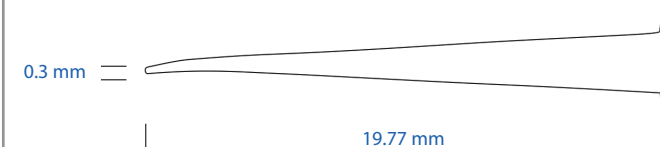

Punctal dilator & lacrimal probe double ended ▪ PD07 ▪ RUPD07 ▪ TIPD07

Length: 14 cm
 Handle length: 70 mm
 curved and pointed end



Surgitrac® Instruments Group Limited
10 Wharfside Business Park
Irlam Wharf Road
Manchester
M44 5PN
United Kingdom

+44 (0)161 776 7626
info@surgitrac.com
www.surgitrac.com

Medix 21
29 Jarden Mile
Ngauranga Wellington 6035
New Zealand

+64 4 233 1627
admin@medix21.co.nz
www.medix21.co.nz



United Kingdom
France
Hong Kong
China